

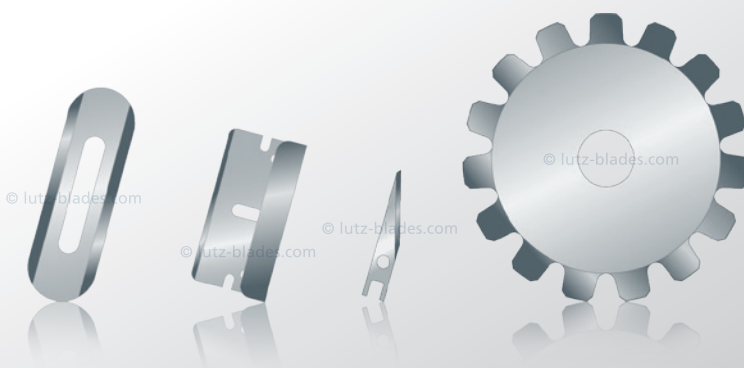

**BLADES THAT MEET HIGHEST QUALITY
STANDARDS EVERY TIME – BLADES AND KNIVES FOR
THE AUTOMOTIVE INDUSTRY BY LUTZ BLADES**



PRECISION. SHARPNESS. YOUR SUCCESS.
exactly

- CUSTOM BLADES
- FILM AND FOIL
- CHEMICAL FIBRES AND FIBREGLASS
- MEDICAL
- FOOD
- DIY
- AUTOMOTIVE**
- TEXTILES

Reasons why you need LUTZ BLADES:



PRECISION.

Our maxim is precision – and it is this principle that accompanies every stage from the initial idea to the finished product. Right through to the ideal solution for your specific cutting application to ensure your requirements are met. Throughout every design and development stage and every production step – blade after blade after blade.



SHARPNESS.

We have been making blades and cutters since 1922. From razor-sharp, for extremely fine cutting jobs to extremely robust for impact and pressure cutting actions. Together with the customer, we define all the relevant parameters to ensure your individual requirements are met – to provide greater sharpness and better service lifetimes.

YOUR SUCCESS.

exactly

Your competitive advantage when you use blades from LUTZ BLADES for automotive cutting applications is the sum of all our efforts and the details we guarantee you. We are pleased to show you those details because your success is our objective – from the first to the millionth blade.

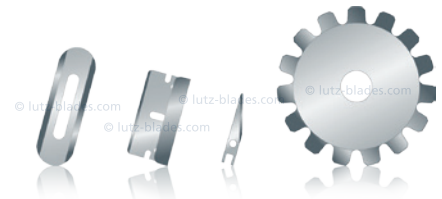

INDUSTRIAL BLADES AND KNIVES BY LUTZ BLADES FOR AUTOMOTIVE OEM SUPPLIERS

We know automotive suppliers require blades that are highly efficient and manufactured with the highest quality standards.



CUSTOM BLADES | FILM AND FOIL | CHEMICAL FIBRES AND FIBREGLASS | MEDICAL | FOOD | DIY | **AUTOMOTIVE** | TEXTILES

LUTZ BLADES allows access to all its website content for viewing purposes. Copying and reproducing content (copy, images etc.) for anything more than transient use is not permitted. This content may not be modified or used on other websites or networked computers without prior written approval by LUTZ GmbH & Co. KG.

Copyright: © COPYRIGHT LUTZ GmbH & Co. KG, Solingen, Germany. All rights reserved. Copy, photos, graphics, technical drawings, layouts and other information used in all our publications and their arrangements on our LUTZ BLADES website are subject to copyright and other proprietary rights.

Proprietary rights: The owner of the brandnames used by LUTZ BLADES is LUTZ GmbH & Co. KG, Solingen, Germany (unless otherwise stated). Third Parties are explicitly prohibited from using any of the brandnames, logos or marks of any kind found there. This applies in particular to the use of any of the brandnames, logos or marks of LUTZ BLADES, which are registered as trademarks, in connection with any other goods or services. LUTZ BLADES will pursue all violations against trademark law regarding its trademarks.
E & OE. Brandnames marked with an asterisk (*) are not owned by LUTZ GmbH & Co. KG. Subject to our general terms & conditions on the internet at: www.lutz-blades.com.

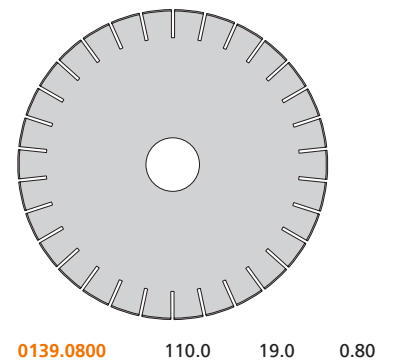
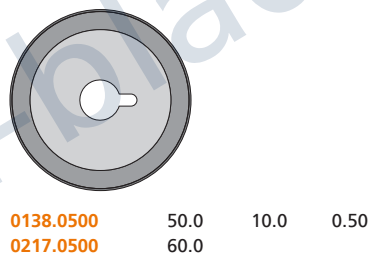
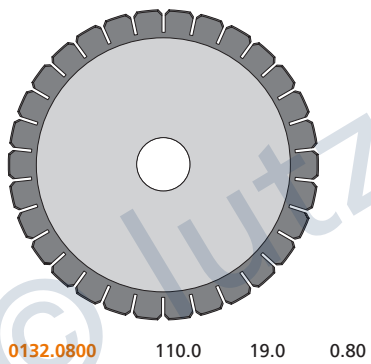
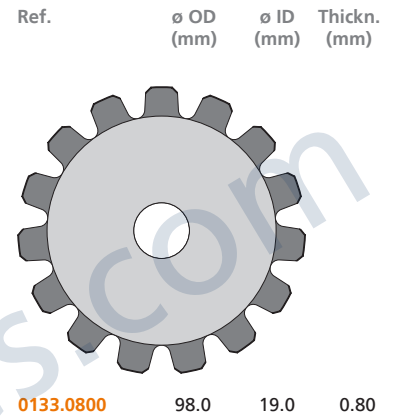
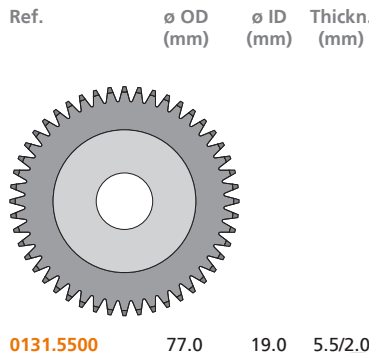
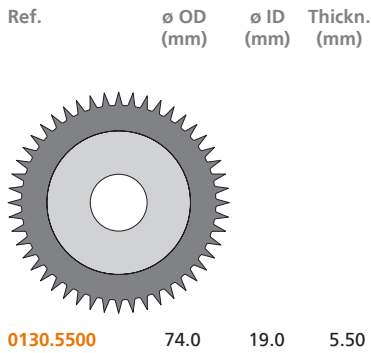

THIS IS HOW YOU CAN BENEFIT FROM INDUSTRIAL BLADES AND KNIVES BY LUTZ BLADES

- » Peak quality in cutting processes thanks to adherence to the closest tolerances and consistency throughout the production run.
- » Adaptation of the blade to meet your specific production parameters.
- » High productivity through reduction in production downtimes
- » Less scrap (e.g. from microcracks when cutting glass)
- » High degree of process dependability thanks to specific identification marks on the blades
- » Safe working methods due to simple handling, thanks to patented packaging



CUSTOM BLADES | FILM AND FOIL | CHEMICAL FIBRES AND FIBREGLASS | MEDICAL | FOOD | DIY | AUTOMOTIVE | TEXTILES

LUTZ BLADES allows access to all its website content for viewing purposes. Copying and reproducing content (copy, images etc.) for anything more than transient use is not permitted. This content may not be modified or used on other websites or networked computers without prior written approval by LUTZ GmbH & Co. KG.

Copyright: © COPYRIGHT LUTZ GmbH & Co. KG, Solingen, Germany. All rights reserved. Copy, photos, graphics, technical drawings, layouts and other information used in all our publications and their arrangements on our LUTZ BLADES website are subject to copyright and other proprietary rights.

Proprietary rights: The owner of the brandnames used by LUTZ BLADES is LUTZ GmbH & Co. KG, Solingen, Germany (unless otherwise stated). Third Parties are explicitly prohibited from using any of the brandnames, logos or marks of any kind found here. This applies in particular to the automatic registration of trademarks, logos or marks which are registered trademarks of LUTZ BLADES. LUTZ BLADES will pursue all violations against trademark law regarding its trademarks.
E & OE. Brandnames marked with an asterisk (*) are not owned by LUTZ GmbH & Co. KG. Subject to our general terms & conditions on the internet at: www.lutz-blades.com.

Ref.	Length (mm)	Width (mm)	Thickn. (mm)
	59.0	18.8	0.40
0698.0400			

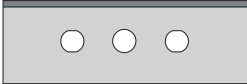
Ref.	Length (mm)	Width (mm)	Thickn. (mm)
	60.0	22.2	0.10
0600.0100			0.13
0600.0150			0.15
0600.0200			0.20
0600.0300			0.30

Ref.	Length (mm)	Width (mm)	Thickn. (mm)
	90.4	9.1	0.40
1720.0400			

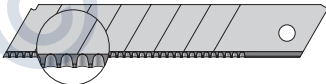
Ref.	Length (mm)	Width (mm)	Thickn. (mm)
	100.0	17.7	0.50
2026.0500			

Ref.	Length (mm)	Width (mm)	Thickn. (mm)
	96.0	12.0	0.50
1714.0500			



Ref.	Length (mm)	Width (mm)	Thickn. (mm)
	40.0	18.9	0.30
0317.0300			

Ref.	Length (mm)	Width (mm)	Thickn. (mm)
	39.8	19.5	0.23
0308.0228			

Ref.	Length (mm)	Width (mm)	Thickn. (mm)
	17.8	9.5	0.43
3190.0430			

Ref.	Length (mm)	Width (mm)	Thickn. (mm)
	variable	7.9	0.25
3286.0250			

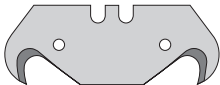
Ref.	Length (mm)	Width (mm)	Thickn. (mm)
	95.3	18.8	0.65
1024.0650			

Ref.	Length (mm)	Width (mm)	Thickn. (mm)
	50.7	18.7	0.50
1251.0500			
			0.65
1251.0650			

Ref.	Length (mm)	Width (mm)	Thickn. (mm)
	11.0	18.9	0.30
0309.0300			

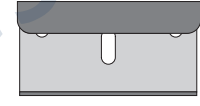
Ref.	Length (mm)	Width (mm)	Thickn. (mm)
	40.0	19.9	0.25
0300.0250			

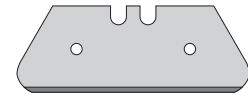
Ref.	Length (mm)	Width (mm)	Thickn. (mm)
	51.3	18.7	0.40
1098.0400			

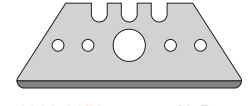
Ref.	Length (mm)	Width (mm)	Thickn. (mm)
	49.5	18.7	0.65
1009.0650			

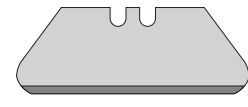
Ref.	Length (mm)	Width (mm)	Thickn. (mm)
	51.3	18.7	0.65
1099.0650			

POINTED BLADES BY LUTZ BLADES HAVE THE FOLLOWING CHARACTERISTICS

- » The best materials
- » Defined point radius
- » Razor-sharp on both cutting edges
- » Centred points
- » Adherence to the closest tolerances











CUSTOM BLADES | FILM AND FOIL | CHEMICAL FIBRES AND FIBREGLASS | MEDICAL | FOOD | DIY | **AUTOMOTIVE** | TEXTILES

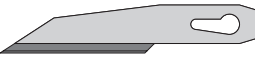

LUTZ BLADES allows access to all its website content for viewing purposes. Copying and reproducing content (copy, images etc.) for anything more than transient use is not permitted. This content may not be modified or used on other websites or networked computers without prior written approval by LUTZ GmbH & Co. KG.

Copyright: © COPYRIGHT LUTZ GmbH & Co. KG, Solingen, Germany. All rights reserved. Copy, photos, graphics, technical drawings, layouts and other information used in all our publications and their arrangements on our LUTZ BLADES website are subject to copyright and other proprietary rights.

Proprietary rights: The owner of the brandnames used by LUTZ BLADES is LUTZ GmbH & Co. KG, Solingen, Germany (unless otherwise stated). Third Parties are explicitly prohibited from using any of the brandnames, logos or marks of any kind found there. This applies in particular to the use of any marks, logos or marks which are similar to the marks which are registered as trademarks of LUTZ BLADES, which will pursue all violations against trademark law regarding its trademarks.
E & OE. Brandnames marked with an asterisk (*) are not owned by LUTZ GmbH & Co. KG. Subject to our general terms & conditions on the internet at: www.lutz-blades.com.

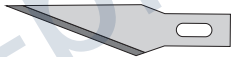
Ref.	Length (mm)	Width (mm)	Thickn. (mm)
 6401.0500	34.5	5.8	0.50
6403.0400			0.40
 6395.0500	33.3	5.8	0.50
 7250.0650	59.4	11.1	0.65
 7251.0650	57.0	11.1	0.65
 6390.0500	36.0	5.5	0.50

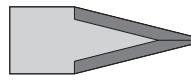
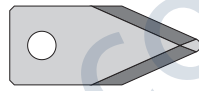
Ref.	Length (mm)	Width (mm)	Thickn. (mm)
 8095.0630	43.0	11.0	0.63
 0029.0500	43.3	9.3	0.50
 0170.0630	41.5	9.1	0.63
 8000.0500	40.2	5.9	0.50

Ref.	Length (mm)	Width (mm)	Thickn. (mm)
 0024.0650	23.2	8.3	0.65
 0046.1000	20.8	8.6	1.00
 0049.0700	15.5	10.0	0.70
 9014.0630	27.0	8.5	0.63

CHOICE OF MATERIAL

Our range of products covers blades of between 0.06 and 3.0 mm in thickness and with final hardness ratings of 40 - 85 HRc.

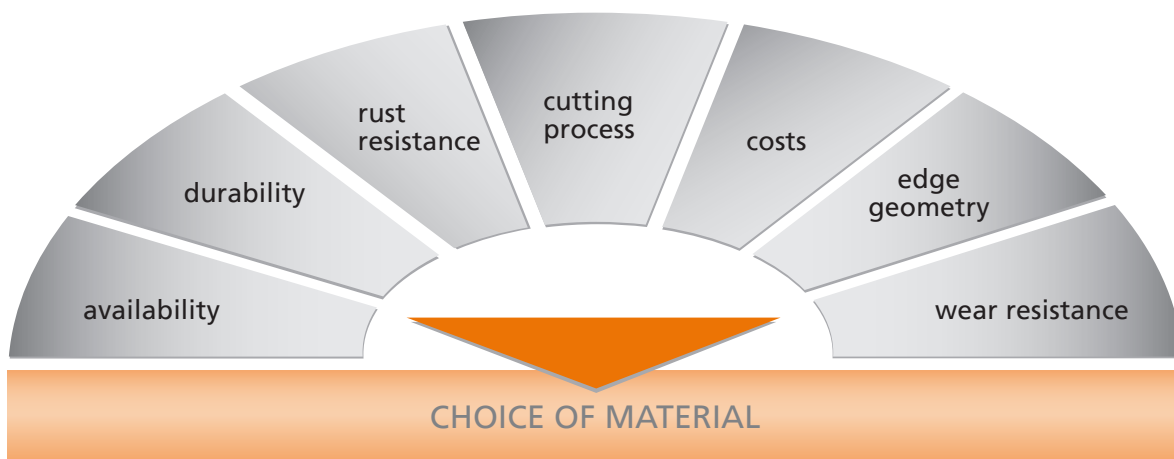

- Our range of materials includes:
- » Carbon steels
 - » Stainless and rust-resistant steels
 - » Highspeed steels (HSS)
 - » Tool steels
 - » Tungsten carbides
 - » Ceramics

LUTZ BLADES allows access to all its website content for viewing purposes. Copying and reproducing content (copy, images etc.) for anything more than transient use is not permitted. This content may not be modified or used on other websites or networked computers without prior written approval by LUTZ GmbH & Co. KG.

Copyright: © COPYRIGHT LUTZ GmbH & Co. KG, Solingen, Germany. All rights reserved. Copy, photos, graphics, technical drawings, layouts and other information used in all our publications and their arrangements on our LUTZ BLADES website are subject to copyright and other proprietary rights.

Proprietary rights: The owner of the brandnames used by LUTZ BLADES is LUTZ GmbH & Co. KG, Solingen, Germany (unless otherwise stated). Third Parties are explicitly prohibited from using any of the brandnames, logos or marks of any kind found here. This applies in particular to the use of any of the registered trademarks, logos or marks which automatically registers a trademark symbol. LUTZ BLADES will pursue all violations against trademark law regarding its trademarks.
E & OE. Brandnames marked with an asterisk (*) are not owned by LUTZ GmbH & Co. KG. Subject to our general terms & conditions on the internet at: www.lutz-blades.com.

CUTTING EDGE SHAPES

For the definition of edge type and bevel configuration see the following matrix:



LUTZ BLADES allows access to all its website content for viewing purposes. Copying and reproducing content (copy, images etc.) for anything more than transient use is not permitted. This content may not be modified or used on other websites or networked computers without prior written approval by LUTZ GmbH & Co. KG.

Copyright: © COPYRIGHT LUTZ GmbH & Co. KG, Solingen, Germany. All rights reserved. Copy, photos, graphics, technical drawings, layouts and other information used in all our publications and their arrangements on our LUTZ BLADES website are subject to copyright and other proprietary rights.

Proprietary rights: The owner of the brandnames used by LUTZ BLADES is LUTZ GmbH & Co. KG, Solingen, Germany (unless otherwise stated). Third Parties are explicitly prohibited from using any of the brandnames, logos or marks of any kind found here. This applies in particular to the automatic registration of trademarks, logos or marks, which, in connection with the trademarks, logos or marks, will pursue all violations against trademark law regarding its trademarks.
E & OE. Brandnames marked with an asterisk (*) are not owned by LUTZ GmbH & Co. KG. Subject to our general terms & conditions on the internet at: www.lutz-blades.com.

		single edged	double edged	convex	concave
two sided		f	l	s	y
		e	k	r	x
		d	j	p	w
		c	i	o	v
		b	h	n	u
		a	g	m	t
one sided		g	h	n	u
		h	i	o	v
		i	j	p	w
		j	k	r	x
		k	l	s	y
		l	m	t	
		m	n	u	
		n	o	v	
		o	p	w	
		p	q	r	
		q	r	s	
		r	s	t	
		s	t	u	
		t	u	v	
		u	v	w	
		v	w	x	
		w	x	y	
		x	y	z	
		y	z		
		z			

COATINGS

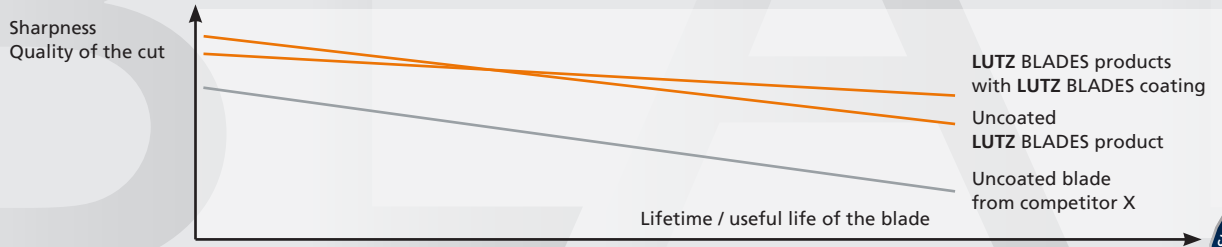

The LUTZ BLADES coatings range includes the following choices:

TiN

Standard hard coating with tough resistance to wear with a relatively high coefficient of friction (compared with steel as a reference material: 0.4 to 0.7), usually gold coloured, safe use at up to approx. 300 °C.

TiC

Has lower resistance to wear than TiN and a considerably lower coefficient of friction (compared with steel as a reference material: 0.3 to 0.5), usually charcoal grey.

TiCN

Takes a position between the high wear resistance of TiN and the low coefficient of friction of TiC, relative position between TiN and TiC depending on C and N content, usually charcoal grey.

TiAlN

Has greater resistance to oxidation than TiN with a comparable coefficient of friction, usually charcoal grey.

ZrN

With wear resistance similar to TiN, but with a more dense morphology than TiN and, as a result, more resistant to pitting under comparable load, usually steel colour.

CrN

Lower wear resistance than TiN. The advantage of CrN is it has a lower inherent tension than TiN. As a result, can be used for applications with high bending loads.

DLC

Has a high wear resistance and a low coefficient of friction (approx. 0.4 compared with steel as a reference); sensitive to impacts and high temperatures (between 100° and 300 °C depending on structure).

Teflon® (PTFE)

Non-stick coating Teflon® (PTFE), very low static friction allows a smooth cut, therefore a popular coating for medical devices. Because of the low surface tension almost no contamination from the cut goods. Acid and base-resistant, not suitable in combination with Na (sodium). Temperature resistant up to 250°C (480°F). Medium wear resistance.

Coloured lacquer

Applied to entire surface, acts as an aid to sorting different material thicknesses and as anticorrosion protection.

Blueing and blackening

Applied to entire surface, some anticorrosion protection and thickness protection, also aids differentiation.

LUTZ BLADES allows access to all its website content for viewing purposes. Copying and reproducing content (copy, images etc.) for anything more than transient use is not permitted. This content may not be modified or used on other websites or networked computers without prior written approval by LUTZ GmbH & Co. KG.

Copyright: © COPYRIGHT LUTZ GmbH & Co. KG, Solingen, Germany. All rights reserved. Copy, photos, graphics, technical drawings, layouts and other information used in all our publications and their arrangements on our LUTZ BLADES website are subject to copyright and other proprietary rights.

Proprietary rights: The owner of the brandnames used by LUTZ BLADES is LUTZ GmbH & Co. KG, Solingen, Germany (unless otherwise stated). Third Parties are explicitly prohibited from using any of the brandnames, logos or marks of any kind found there. This applies in particular to the use of any of the brandnames, logos or marks of LUTZ BLADES which are registered as trademarks. LUTZ BLADES will pursue all violations against trademark law regarding its trademarks.
E & OE. Brandnames marked with an asterisk (*) are not owned by LUTZ GmbH & Co. KG. Subject to our general terms & conditions on the internet at: www.lutz-blades.com.