

<b>ART. N101</b>	Telaio/Loom AC2/S TP1	Lungh. nastro Tape length	Codice Lamiflex Lamiflex Code	Variante Variant
DX/RIGHT	210	1900 mm	N101 1900	B Bianco - White type N Nero - Black type
	330	2450 mm	N101 2450	
	380	2700 mm	N101 2700	
	420	3100 mm	N101 3100	
	460	3400 mm	N101 3400	

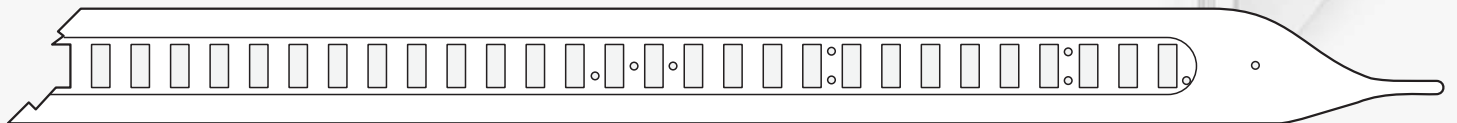

<b>ART. N102</b>	Telaio/Loom AC2/S TP1	Lungh. nastro Tape length	Codice Lamiflex Lamiflex Code	Variante Variant
SX/LEFT	210	1900 mm	N102 1900	B Bianco - White type N Nero - Black type
	330	2450 mm	N102 2450	
	380	2700 mm	N102 2700	
	420	3100 mm	N102 3100	
	460	3400 mm	N102 3400	

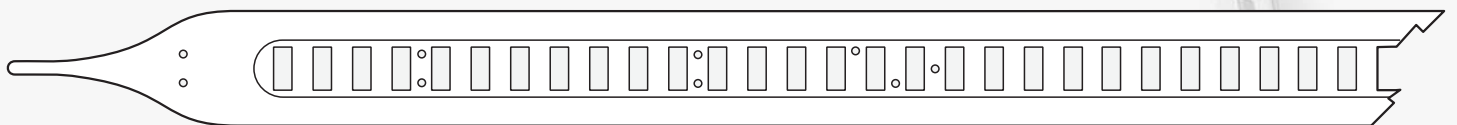

<b>ART. N103</b>	Telaio/Loom AC2/S TP2	Lungh. nastro Tape length	Codice Lamiflex Lamiflex Code	Variante Variant
DX/RIGHT	210	1900 mm	N103 1900	B Bianco - White type N Nero - Black type
	330	2450 mm	N103 2450	
	380	2700 mm	N103 2700	
	420	3100 mm	N103 3100	
	460	3400 mm	N103 3400	

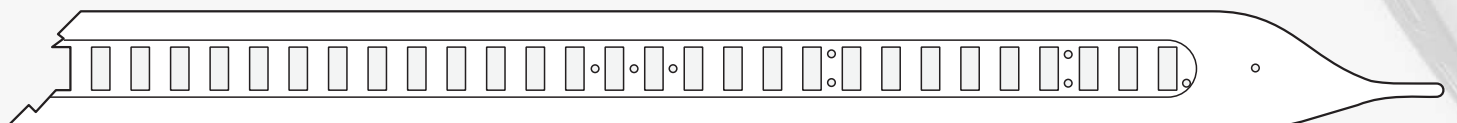

<b>ART. N104</b>	Telaio/Loom AC2/S TP2	Lungh. nastro Tape length	Codice Lamiflex Lamiflex Code	Variante Variant
SX/LEFT	210	1900 mm	N104 1900	B Bianco - White type N Nero - Black type
	330	2450 mm	N104 2450	
	380	2700 mm	N104 2700	
	420	3100 mm	N104 3100	
	460	3400 mm	N104 3400	

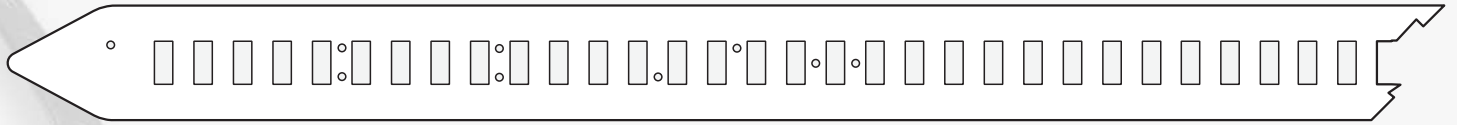

<b>ART. N105</b>	Telaio/Loom UV770	Lungh. nastro Tape length	Codice Lamiflex Lamiflex Code
DX-SX/RIGHT-LEFT	190	1920 mm	N105 1920
SPESSORE 2,5 mm THICKNESS 2,5 mm	210	2020 mm	N105 2020
	230	2120 mm	N105 2120
	260	2360 mm	N105 2360
	300	2560 mm	N105 2560
	340	2760 mm	N105 2760
	360	2880 mm	N105 2880

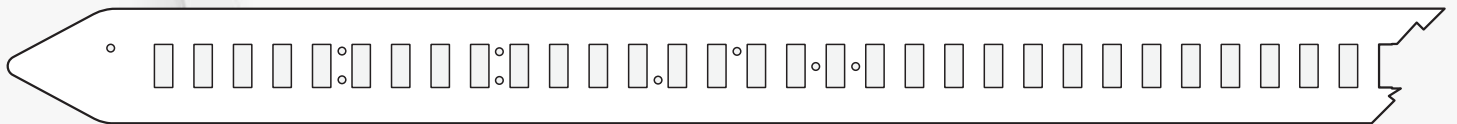

<b>ART. N106</b>	Telaio/Loom UV770	Lungh. nastro Tape length	Codice Lamiflex Lamiflex Code
DX-SX/RIGHT-LEFT	190	1690 mm	N106 1690
SPESSORE 3 mm THICKNESS 3 mm	210	1790 mm	N106 1790
	230	1890 mm	N106 1890
	260	2130 mm	N106 2130
	300	2330 mm	N106 2330
	340	2530 mm	N106 2530
	360	2650 mm	N106 2650

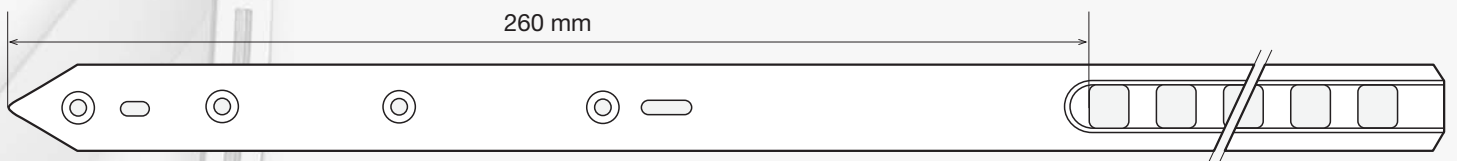

<b>ART. N107</b>	Telaio/Loom THEMA 11	Lungh. nastro Tape length	Codice Lamiflex Lamiflex Code	Variante Variant	
DX-SX/RIGHT-LEFT	165	2056 mm	N107 2056	<b>C</b> Per cotone - For cotton	
	190	2187 mm	N107 2187		
	210	2287 mm	N107 2287		
	220	2330 mm	N107 2330		
	230	2385 mm	N107 2385		
	260	2593 mm	N107 2593		
	280	2692 mm	N107 2692		
	300	2791 mm	N107 2791		
	320	2890 mm	N107 2890		<b>S</b> Per seta - For silk
	340	2988 mm	N107 2988		
	360	3098 mm	N107 3098		
	380	3197 mm	N107 3197		
	400	3295 mm	N107 3295		

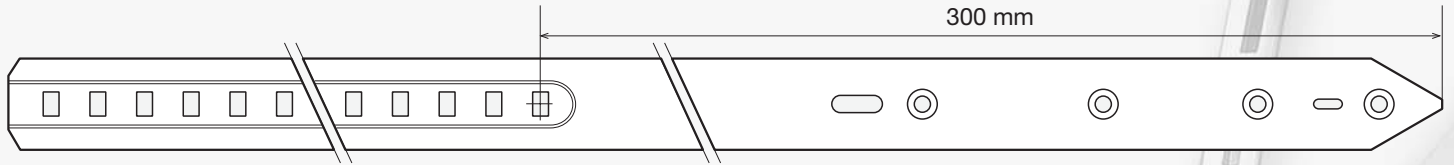

<b>ART. N107 B</b>	Telaio/Loom ALPHA GFG	Lungh. nastro Tape length	Codice Lamiflex Lamiflex Code	Variante Variant
DX-SX/RIGHT-LEFT	170	2175 mm	N107B 2175	C Per cotone - For cotton
	190	2258 mm	N107B 2258	
	210	2357 mm	N107B 2357	
	220	2398 mm	N107B 2398	
	230	2456 mm	N107B 2456	
	260	2663 mm	N107B 2663	
	280	2763 mm	N107B 2763	
	300	2862 mm	N107B 2862	
	320	2961 mm	N107B 2961	
	340	3060 mm	N107B 3060	
	360	3168 mm	N107B 3168	
	380	3267 mm	N107B 3267	
	400	3367 mm	N107B 3367	
	420	3466 mm	N107B 3466	
460	3665 mm	N107B 3665		

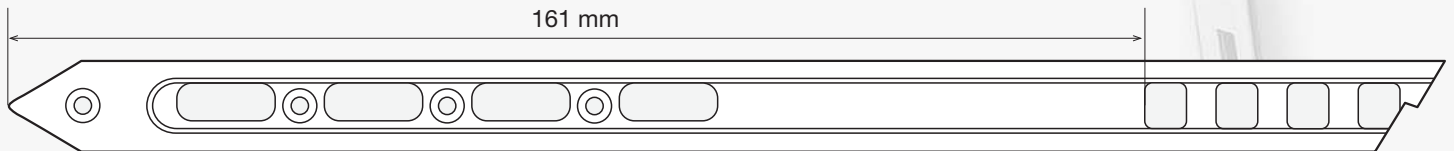

<b>ART. N108</b>
DX-SX/RIGHT-LEFT

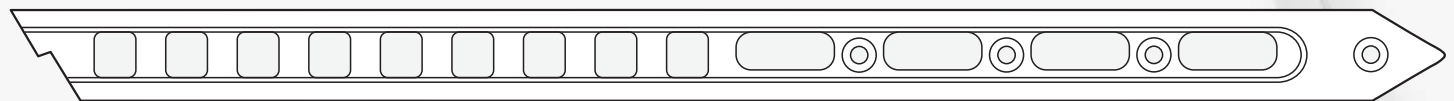

<b>ART. N850</b>	Telaio/Loom MASTER SM92-SM93	Lungh. nastro Tape length	Codice Lamiflex Lamiflex Code	Variante Variant
DX-SX/RIGHT-LEFT	165	1891 mm	N108 1891   N850 1891	C Per cotone For cotton
	190	2001 mm	N108 2001   N850 2001	
	210-220	2155 mm	N108 2155   N850 2155	
	230	2199 mm	N108 2199   N850 2199	
	260	2418 mm	N108 2418   N850 2418	
	280	2528 mm	N108 2528   N850 2528	
	320	2725 mm	N108 2725   N850 2725	
	340	2813 mm	N108 2813   N850 2813	
	360	2923 mm	N108 2923   N850 2923	
	380	3021 mm	N108 3021   N850 3021	
	420	3218 mm	N108 3218   N850 3218	
	460	3406 mm	N108 3406   N850 3406	S Per seta For silk

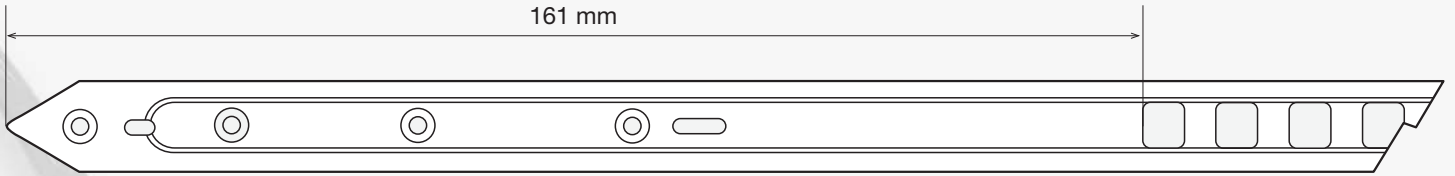

<b>ART. N109</b>	Telaio/Loom MASTER SM92-SM93	Lungh. nastro Tape length	Codice Lamiflex Lamiflex Code	Variante Variant
DX-SX/RIGHT-LEFT				
PER PINZA THEMA FOR THEMA GRIPPER	165	1892 mm	N109 1892	C Per cotone - For cotton
	190	2000 mm	N109 2000	
	210	2154 mm	N109 2154	
	230	2198 mm	N109 2198	
	260	2417 mm	N109 2417	
	280	2527 mm	N109 2527	
	320	2724 mm	N109 2724	
	340	2812 mm	N109 2812	
	360	2922 mm	N109 2922	S Per seta - For silk
	380	3020 mm	N109 3020	
	420	3219 mm	N109 3219	
	460	3405 mm	N109 3405	

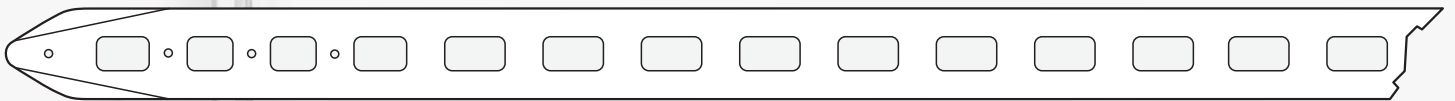

<b>ART. N110</b>	Telaio/Loom ST880	Lungh. nastro Tape length	Codice Lamiflex Lamiflex Code
DX-SX/RIGHT-LEFT			
	190	1956 mm	N110 1956
	220	2044 mm	N110 2044
	230	2154 mm	N110 2154
	260	2395 mm	N110 2395
	310	2593 mm	N110 2593
	340	2790 mm	N110 2790
	360	2900 mm	N110 2900

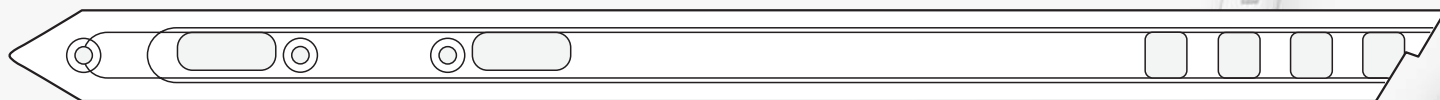

<b>ART. N111</b>	Telaio/Loom THEMA	Lungh. nastro Tape length	Codice Lamiflex Lamiflex Code	Variante Variant
DX-SX/RIGHT-LEFT	165	2099 mm	N111 2099	
	190	2209 mm	N111 2209	
	210-220	2362 mm	N111 2362	
	230	2418 mm	N111 2418	
	260	2626 mm	N111 2626	
	280	2725 mm	N111 2725	C Per cotone - For cotton
	300 320	2923 mm	N111 2923	
	340	3021 mm	N111 3021	
	360	3130 mm	N111 3130	
	380	3218 mm	N111 3218	S Per seta - For silk
	400	3406 mm	N111 3406	
	420	3525 mm	N111 3525	
	460	3745 mm	N111 3745	

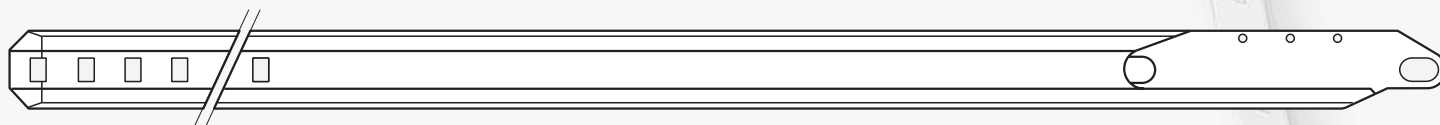

<b>ART. N112</b>	Telaio/Loom EXCEL/MFG	Lungh. nastro Tape length	Codice Lamiflex Lamiflex Code
SX/LEFT	165	1980 mm	N112 1980
	190	2104 mm	N112 2104
	210	2203 mm	N112 2203
	220	2253 mm	N112 2253
	230	2303 mm	N112 2303
	260	2517 mm	N112 2517
	280	2616 mm	N112 2616
	300	2715 mm	N112 2715
	320	2814 mm	N112 2814
	340	2913 mm	N112 2913
	360	3012 mm	N112 3012
	380	3119 mm	N112 3119
	400	3218 mm	N112 3218

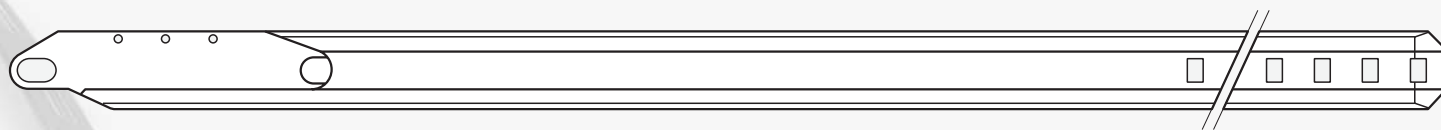

<b>ART. N113</b>	Telaio/Loom EXCEL/MFG	Lungh. nastro Tape length	Codice Lamiflex Lamiflex Code
DX/RIGHT	165	1980 mm	N113 1980
	190	2104 mm	N113 2104
	210	2203 mm	N113 2203
	220	2253 mm	N113 2253
	230	2303 mm	N113 2303
	260	2517 mm	N113 2517
	280	2616 mm	N113 2616
	300	2715 mm	N113 2715
	320	2814 mm	N113 2814
	340	2913 mm	N113 2913
	360	3012 mm	N113 3012
	380	3119 mm	N113 3119
	400	3218 mm	N113 3218

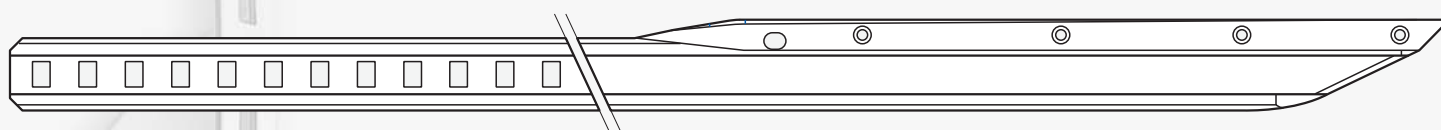

<b>ART. N117</b>	Telaio/Loom EXCEL/MFG	Lungh. nastro Tape length	Codice Lamiflex Lamiflex Code
SX/LEFT	165	2128 mm	N117 2128
	190	2252 mm	N117 2252
PORTANTE	210	2351 mm	N117 2351
	220	2400 mm	N117 2400
	230	2450 mm	N117 2450
	260	2664 mm	N117 2664
	280	2763 mm	N117 2763
	300	2862 mm	N117 2862
	320	2961 mm	N117 2961
	340	3060 mm	N117 3060
	360	3159 mm	N117 3159
	380	3267 mm	N117 3267
	400	3366 mm	N117 3366
	132	1964 mm	N117 1964

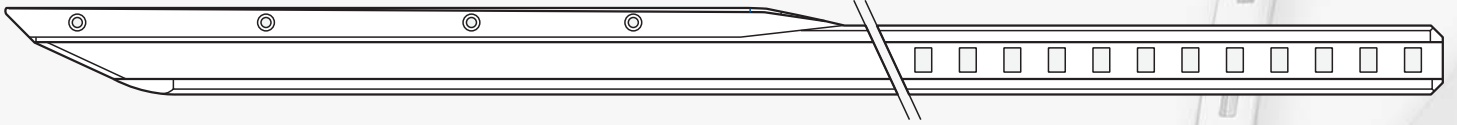

<b>ART. N118</b>	Telaio/Loom EXCEL/MFG	Lungh. nastro Tape length	Codice Lamiflex Lamiflex Code
DX/RIGHT	165	2128 mm	N118 2128
TRAENTE	190	2252 mm	N118 2252
	210	2351 mm	N118 2351
	220	2400 mm	N118 2400
	230	2450 mm	N118 2450
	260	2664 mm	N118 2664
	280	2763 mm	N118 2763
	300	2862 mm	N118 2862
	320	2961 mm	N118 2961
	340	3060 mm	N118 3060
	360	3159 mm	N118 3159
	380	3267 mm	N118 3267
	400	3366 mm	N118 3366
	132	1964 mm	N118 1964

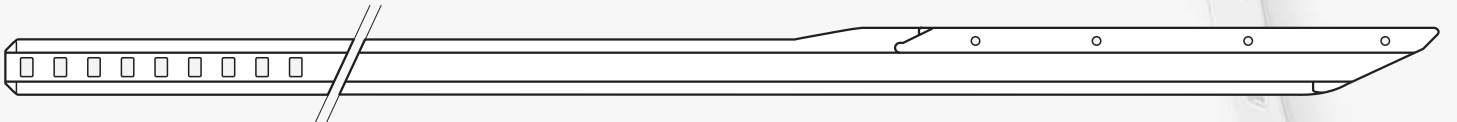

<b>ART. N120</b>	Telaio/Loom ALPHA/MFG	Lungh. nastro Tape length	Codice Lamiflex Lamiflex Code	Variante Variant
SX/LEFT	170	2285 mm	N120 2285	C Per cotone - For cotton
	190	2360 mm	N120 2360	
	210	2459 mm	N120 2459	
	220	2508 mm	N120 2508	
	230	2558 mm	N120 2558	
	260	2772 mm	N120 2772	
	280	2871 mm	N120 2871	
	300	2970 mm	N120 2970	
	320	3069 mm	N120 3069	
	340	3168 mm	N120 3168	
	360	3267 mm	N120 3267	
	380	3374 mm	N120 3374	
	400	3473 mm	N120 3473	
	420	3671 mm	N120 3671	
	460	4076 mm	N120 4076	

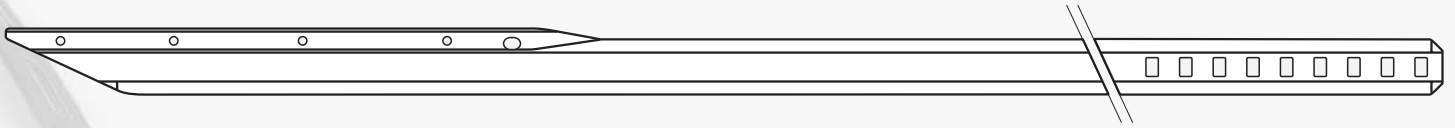

<b>ART. N121</b>	Telaio/Loom ALPHA/MFG	Lungh. nastro Tape length	Codice Lamiflex Lamiflex Code	Variante Variant
DX/RIGHT	170	2285 mm	N121 2285	<b>C</b> Per cotone - For cotton
	190	2360 mm	N121 2360	
	210	2459 mm	N121 2459	
	220	2508 mm	N121 2508	
	230	2558 mm	N121 2558	
	260	2772 mm	N121 2772	
	280	2871 mm	N121 2871	
	300	2970 mm	N121 2970	
	320	3069 mm	N121 3069	
	340	3168 mm	N121 3168	
	360	3267 mm	N121 3267	
	380	3374 mm	N121 3374	
	400	3473 mm	N121 3473	
	420	3671 mm	N121 3671	
	460	4076 mm	N121 4076	



<b>ART. P112</b>
CINGHIETTA/SPRING



<b>ART. P113</b>
PATTINO APRIPINZA/OPENER BLADE





**ART. P114**

PATTINO DI RISCONTRO/OPENER BLADE

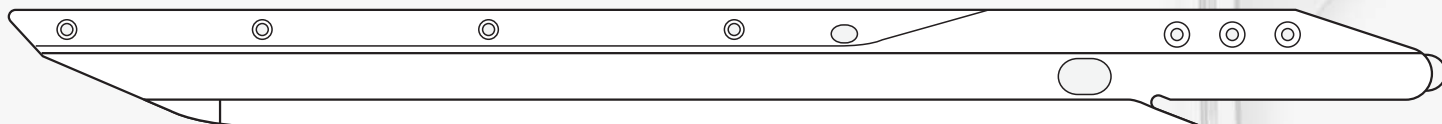

**ART. P119 TR 3,80 CA E CCT**

PROTEZIONE TRAENTE - DX/GRIPPER PROTECTION - RIGHT

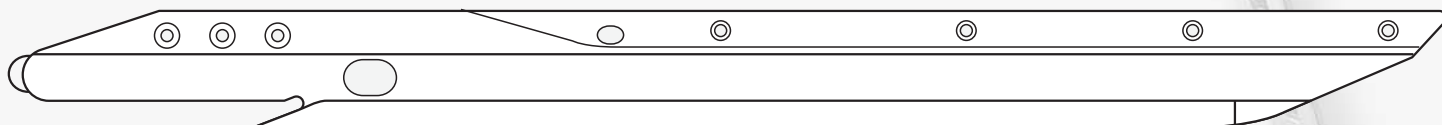

**ART. P119 PT 3,80 CA E CCT**

PROTEZIONE PORTANTE - SX/GRIPPER PROTECTION - LEFT

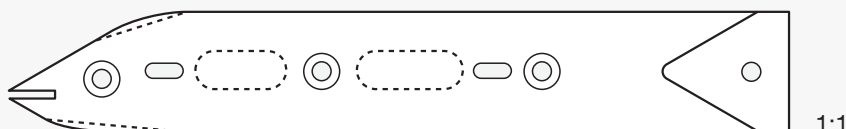

**ART. P121 0106 FN**

PROTEZIONE PER TRAENTE - DX/POINT PROTECTION - RIGHT

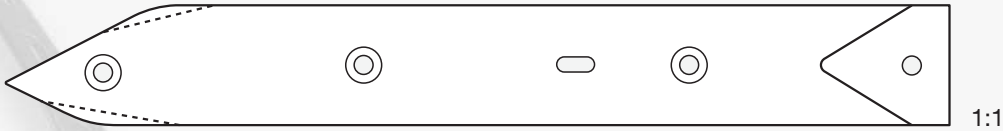

**ART. P121 0126 FN**

PROTEZIONE PER TRAENTE - DX/POINT PROTECTION - RIGHT



**ART. P121 0097 FN**

PROTEZIONE PER PORTANTE - SX/POINT PROTECTION - LEFT



**ART. P121 0097 T1**

PROTEZIONE PER PORTANTE - SX/POINT PROTECTION - LEFT

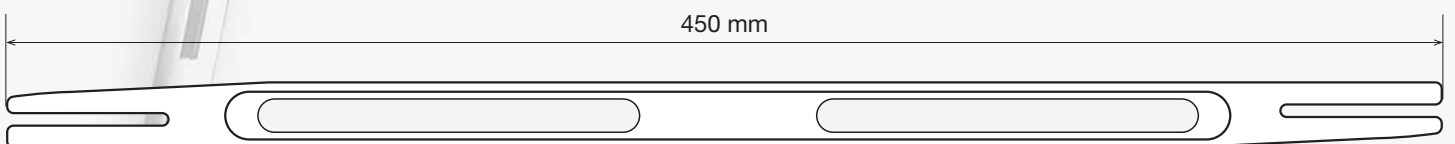

**ART. P125**

PATTINO APRIPINZA/OPENER BLADE

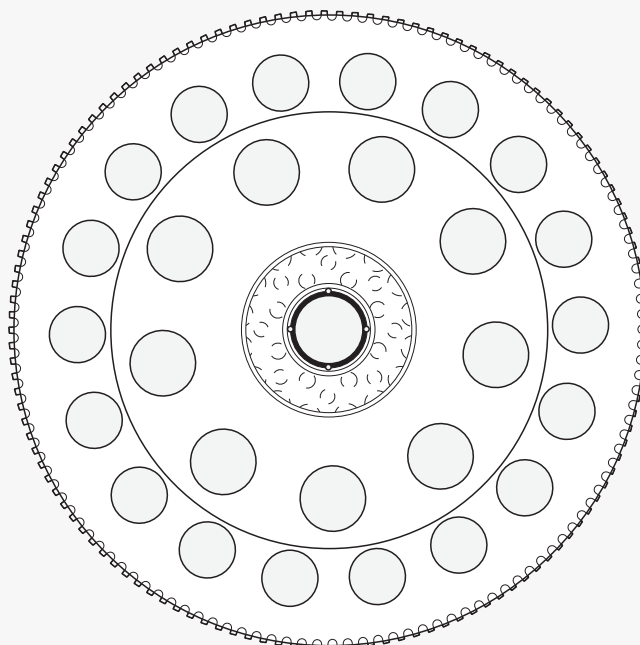

**ART. R001A 129**

RUOTA DENTATA PER NASTRI TIPO EXCEL/TOOTHED WHEEL FOR EXCEL TYPE TAPES

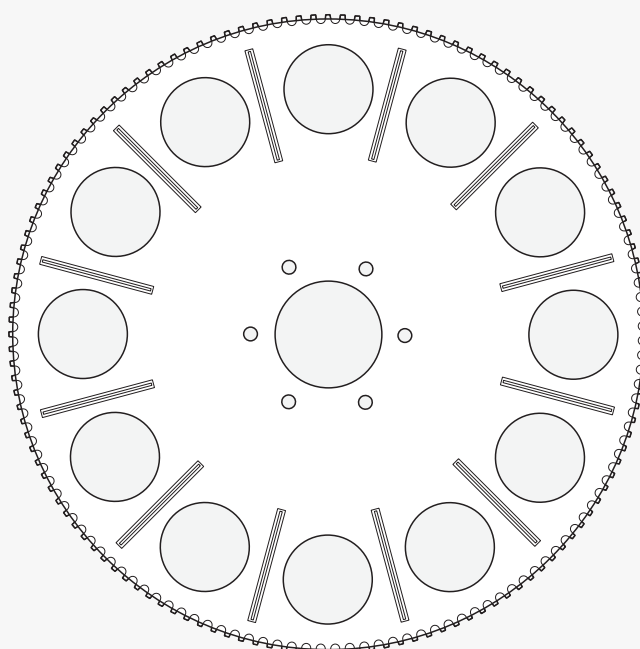

**ART. R023A # 136 M**

RUOTA DENTATA CON ALETTE PER NASTRI TIPO ALPHA/TOOTHED WHEEL WITH FINS FOR ALPHA TYPE TAPES

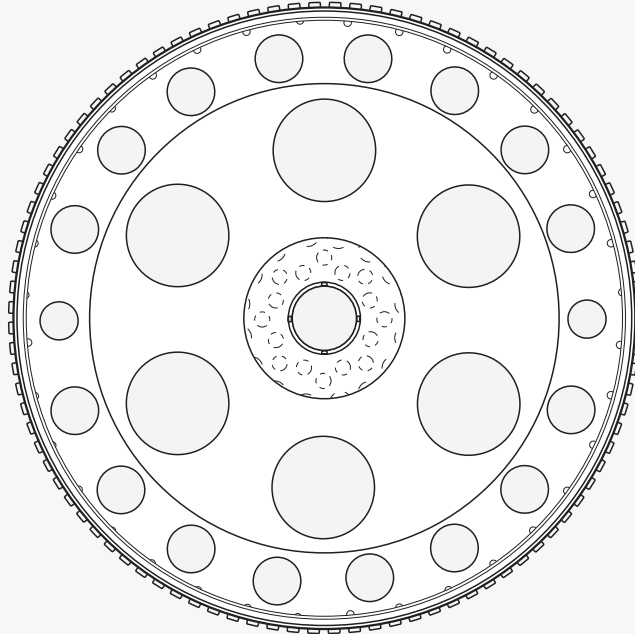
**ART. R011 96T1**RUOTA DENTATA PER NASTRI TIPO THEMA E MASTER  
TOOTHED WHEEL FOR THEMA AND MASTER TYPE TAPES

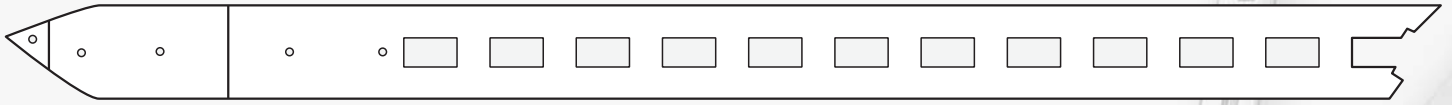

<b>ART. N202</b>	Telaio/Loom C 301-C 401	Lungh. nastro Tape length	Codice Lamiflex Lamiflex Code	Variante Variant
DX-SX/RIGHT-LEFT	160	1780 mm	N202 1780	<b>C</b> Per cotone - For cotton  <b>S</b> Per seta - For silk
	190	1920 mm	N202 1920	
	210	2015 mm	N202 2015	
	230	2110 mm	N202 2110	
	260	2275 mm	N202 2275	
	300	2515 mm	N202 2515	
	320	2610 mm	N202 2610	
	340	2705 mm	N202 2705	
	360	2800 mm	N202 2800	
	380	2895 mm	N202 2895	

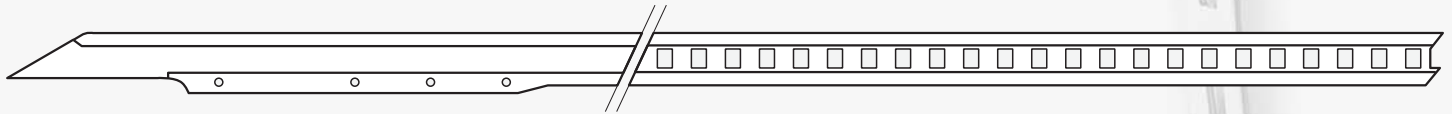

<b>ART. N203</b>	Telaio/Loom P1001	Lungh. nastro Tape length	Codice Lamiflex Lamiflex Code	Variante Variant
DX/RIGHT	1600	2030 mm	N203 2030	<b>C</b> Per cotone - For cotton  <b>S</b> Per seta - For silk
CON PUNTA IN CARBONIO WITH CARBON POINT	1900	2180 mm	N203 2180	
	2100	2280 mm	N203 2280	
	2300	2380 mm	N203 2380	
	2600	2530 mm	N203 2530	
	3000	2760 mm	N203 2760	
	3200	2860 mm	N203 2860	
	3400	2960 mm	N203 2960	
	3600	3060 mm	N203 3060	
	3800	3160 mm	N203 3160	

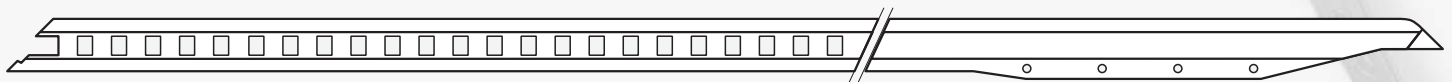

<b>ART. N204</b>	Telaio/Loom P1001	Lungh. nastro Tape length	Codice Lamiflex Lamiflex Code	Variante Variant
SX/LEFT	1600	2190 mm	N204 2190	<b>C</b> Per cotone - For cotton  <b>S</b> Per seta - For silk
CON PUNTA IN CARBONIO WITH CARBON POINT	1900	2340 mm	N204 2340	
	2100	2440 mm	N204 2440	
	2300	2540 mm	N204 2540	
	2600	2690 mm	N204 2690	
	3000	2920 mm	N204 2920	
	3200	3020 mm	N204 3020	
	3400	3120 mm	N204 3120	
	3600	3220 mm	N204 3220	
	3800	3320 mm	N204 3320	

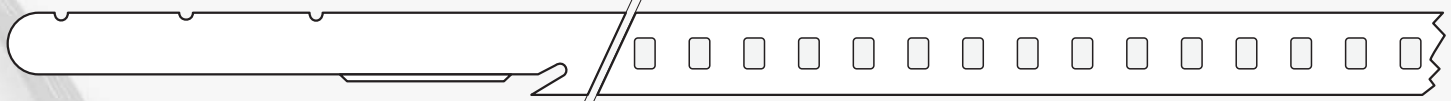

<b>ART. N205</b>	Telaio/Loom P1001	Lungh. nastro Tape length	Codice Lamiflex Lamiflex Code
DX/RIGHT	160	1945 mm	N205 1945
CON PUNTA INTERCAMBIABILE WITH CHANGEABLE POINT	190	2095 mm	N205 2095
	210	2195 mm	N205 2195
	230	2295 mm	N205 2295
	260	2445 mm	N205 2445
	280	2545 mm	N205 2545
	300	2675 mm	N205 2675
	320	2775 mm	N205 2775
	340	2875 mm	N205 2875
	360	2975 mm	N205 2975
	380	3075 mm	N205 3075

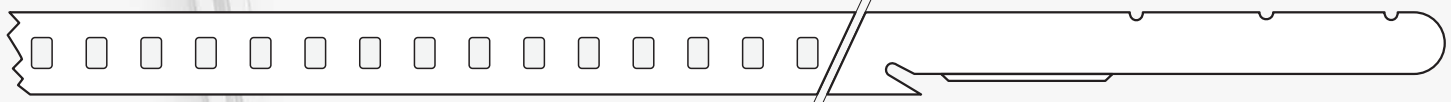

<b>ART. N206</b>	Telaio/Loom P1001	Lungh. nastro Tape length	Codice Lamiflex Lamiflex Code
SX/LEFT	160	2130 mm	N206 2130
CON PUNTA INTERCAMBIABILE WITH CHANGEABLE POINT	190	2280 mm	N206 2280
	210	2380 mm	N206 2380
	230	2480 mm	N206 2480
	260	2630 mm	N206 2630
	280	2730 mm	N206 2730
	300	2860 mm	N206 2860
	320	2960 mm	N206 2960
	340	3060 mm	N206 3060
	360	3160 mm	N206 3160
	380	3260 mm	N206 3260

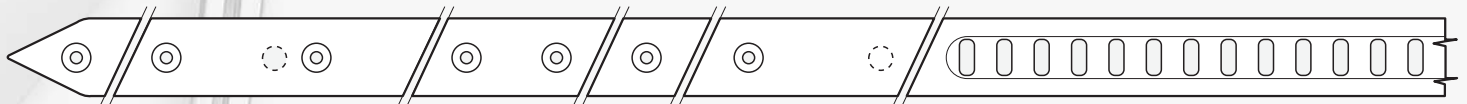

<b>ART. N207</b>	Telaio/Loom 9000 PLUS	Lungh. nastro Tape length	Codice Lamiflex Lamiflex Code	Variante Variant
DX-SX/RIGHT-LEFT	190	2450 mm	N207 2450	C Per cotone - For cotton  S Per seta - For silk
SPESSORE 3 mm THICKNESS 3 mm  CON PUNTA IN CARBONIO WITH CARBON POINT	210	2550 mm	N207 2550	
	230	2650 mm	N207 2650	
	260	2800 mm	N207 2800	
	280	2900 mm	N207 2900	
	300	3030 mm	N207 3030	
	320	3130 mm	N207 3130	
	340	3230 mm	N207 3230	
	360	3330 mm	N207 3330	
380	3430 mm	N207 3430		

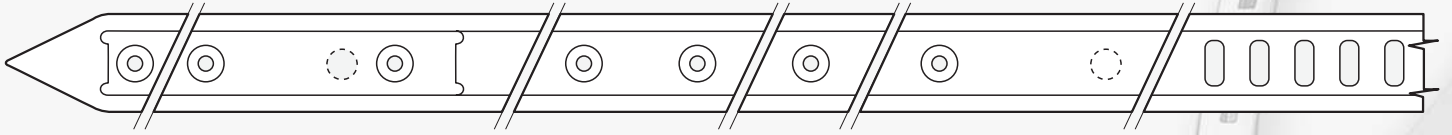

<b>ART. N208</b>	Telaio/Loom 9000 PLUS	Lungh. nastro Tape length	Codice Lamiflex Lamiflex Code
DX-SX/RIGHT-LEFT	190	2450 mm	N208 2450
SPESSORE 4 mm THICKNESS 4 mm	210	2550 mm	N208 2550
	230	2650 mm	N208 2650
	260	2800 mm	N208 2800
	280	2900 mm	N208 2900
	300	3030 mm	N208 3030
	320	3130 mm	N208 3130
	340	3230 mm	N208 3230
	360	3330 mm	N208 3330
	380	3430 mm	N208 3430

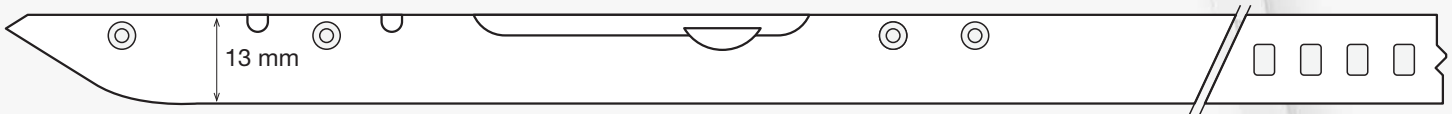

<b>ART. N209</b>	Telaio/Loom LEONARDO	Lungh. nastro Tape length	Codice Lamiflex Lamiflex Code	Variante Variant
DX/RIGHT	170	2140 mm	N209 2140	<b>C</b> Per cotone - For cotton  <b>S</b> Per seta - For silk
	190	2240 mm	N209 2240	
	210	2340 mm	N209 2340	
	220	2390 mm	N209 2390	
	230	2440 mm	N209 2440	
	260	2590 mm	N209 2590	
	280	2690 mm	N209 2690	
	300	2820 mm	N209 2820	
	320	2920 mm	N209 2920	
	340	3020 mm	N209 3020	
	360	3120 mm	N209 3120	
	380	3220 mm	N209 3220	

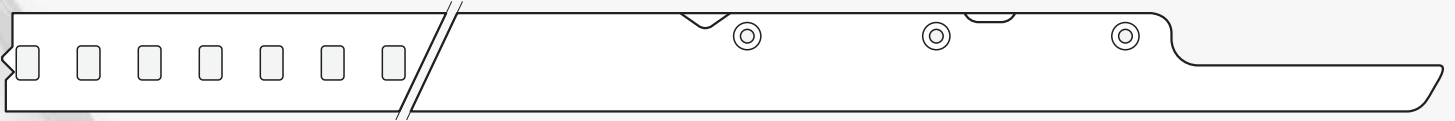

<b>ART. N210</b>	Telaio/Loom LEONARDO	Lungh. nastro Tape length	Codice Lamiflex Lamiflex Code	Variante Variant
SX/LEFT	170	2230 mm	N210 2230	<b>C</b> Per cotone - For cotton  <b>S</b> Per seta - For silk
	190	2330 mm	N210 2330	
	210	2430 mm	N210 2430	
	220	2480 mm	N210 2480	
	230	2530 mm	N210 2530	
	260	2680 mm	N210 2680	
	280	2780 mm	N210 2780	
	300	2910 mm	N210 2910	
	320	3010 mm	N210 3010	
	340	3110 mm	N210 3110	
	360	3210 mm	N210 3210	
	380	3310 mm	N210 3310	

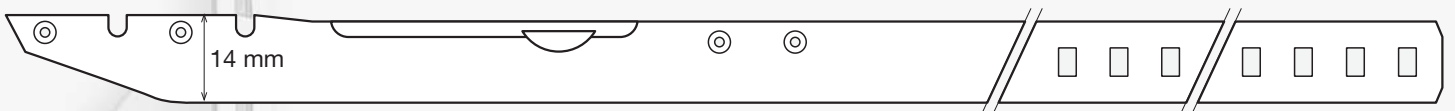

<b>ART. N212</b>	Telaio/Loom LEONARDO	Lungh. nastro Tape length	Codice Lamiflex Lamiflex Code	Variante Variant
DX/RIGHT	170	2122 mm	N212 2122	<b>C</b> Per cotone - For cotton  <b>S</b> Per seta - For silk
	190	2222 mm	N212 2222	
	210	2322 mm	N212 2322	
	220	2372 mm	N212 2372	
	230	2422 mm	N212 2422	
	260	2572 mm	N212 2572	
	280	2672 mm	N212 2672	
	300	2802 mm	N212 2802	
	320	2902 mm	N212 2902	
	340	3002 mm	N212 3002	
	360	3102 mm	N212 3102	
	380	3202 mm	N212 3202	



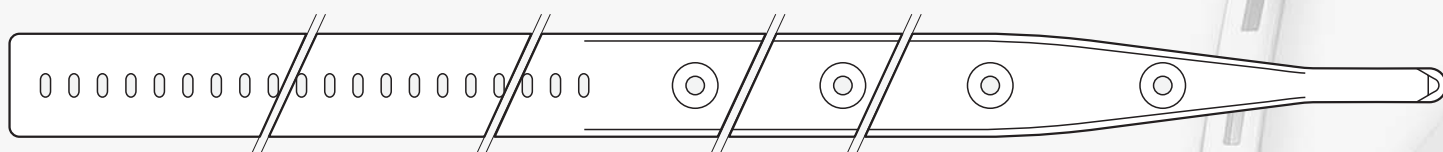

<b>ART. N216</b>	Telaio/Loom LEONARDO FTS	Lungh. nastro Tape length	Codice Lamiflex Lamiflex Code
SX/LEFT	170	2275 mm	N216 2275
	190	2375 mm	N216 2375
	210	2475 mm	N216 2475
	220	2525 mm	N216 2525
	230	2575 mm	N216 2575
	260	2725 mm	N216 2725
	280	2825 mm	N216 2825
	300	2955 mm	N216 2955
	320	3055 mm	N216 3055
	340	3155 mm	N216 3155
	360	3255 mm	N216 3255
	380	3355 mm	N216 3355

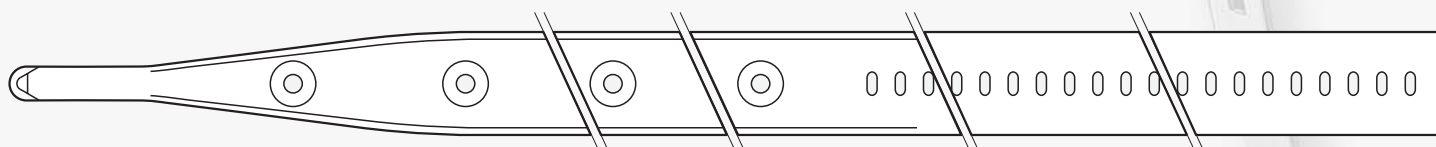

<b>ART. N217</b>	Telaio/Loom LEONARDO FTS	Lungh. nastro Tape length	Codice Lamiflex Lamiflex Code
DX/RIGHT	170	2065 mm	N217 2065
	190	2165 mm	N217 2165
	210	2265 mm	N217 2265
	220	2315 mm	N217 2315
	230	2365 mm	N217 2365
	260	2515 mm	N217 2515
	280	2615 mm	N217 2615
	300	2745 mm	N217 2745
	320	2845 mm	N217 2845
	340	2945 mm	N217 2945
	360	3045 mm	N217 3045
	380	3145 mm	N217 3145

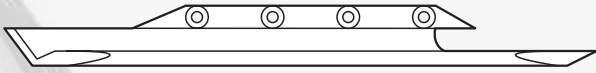

PUNTA SINISTRA  
LEFT POINT  
PT

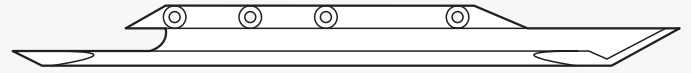

PUNTA DESTRA  
RIGHT POINT  
TR

**ART. P211 PT/TR**

PUNTE - SPESSORE 4/6,5 mm/POINTS - THICKNESS 4/6,5 mm

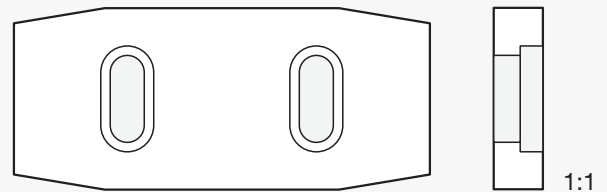
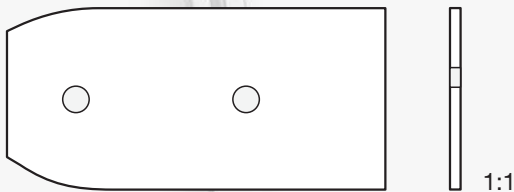

**ART. P212**

PIASTRINA PER PUNTA NASTRO  
POINT PROTECTION

**ART. P213**

PIASTRINA DI REAZIONE  
OPENER BLADE

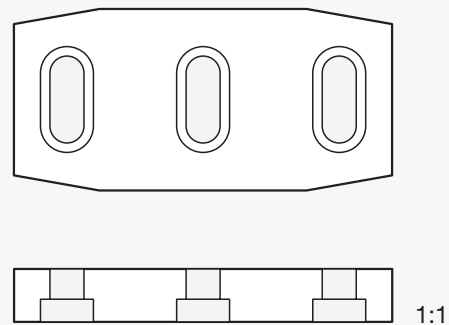
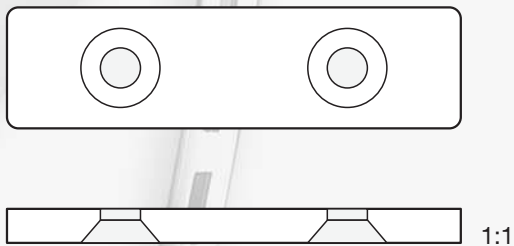

**ART. P214**

PIASTRINA DI REAZIONE  
OPENER BLADE

**ART. P216**

PIASTRINA DI REAZIONE  
OPENER BLADE

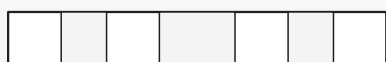
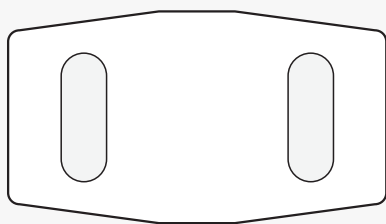

1:1

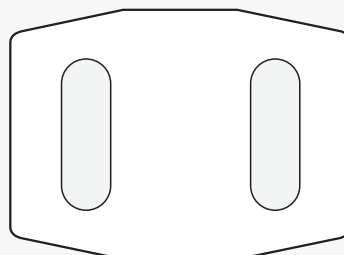

1:1

**ART. P217**

PIASTRINA DI APERTURA  
OPENER BLADE

**ART. P218**

PIASTRINA DI APERTURA PINZA PORTANTE  
OPENER BLADE

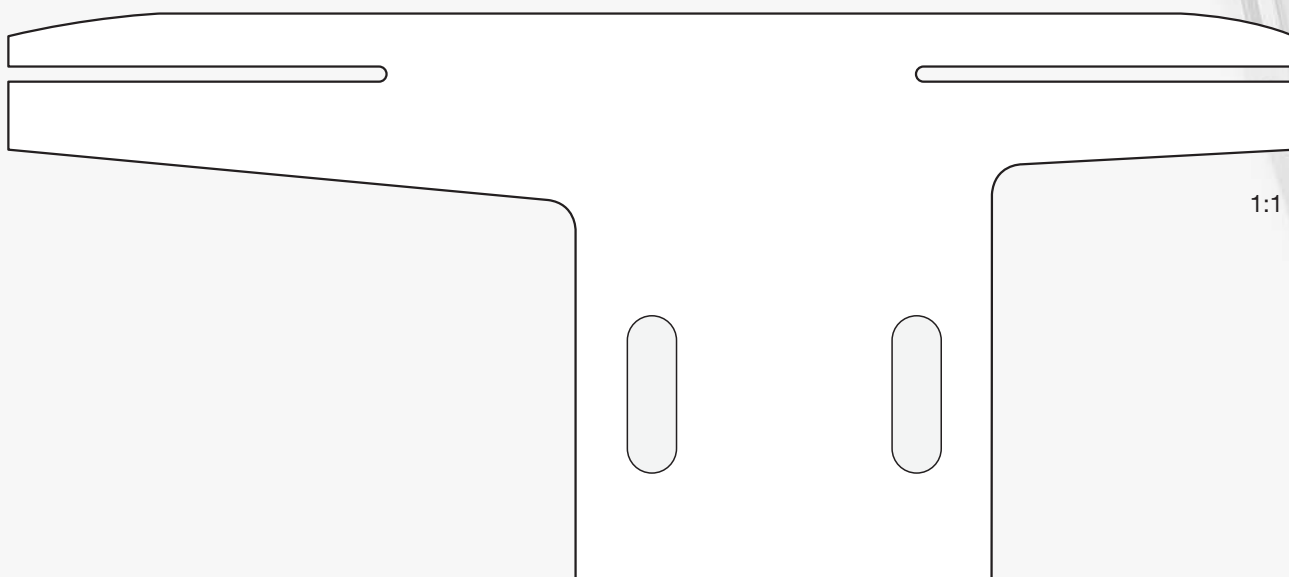

1:1

**ART. P220**

PIASTRINA APRIPINZA/OPENER BLADE

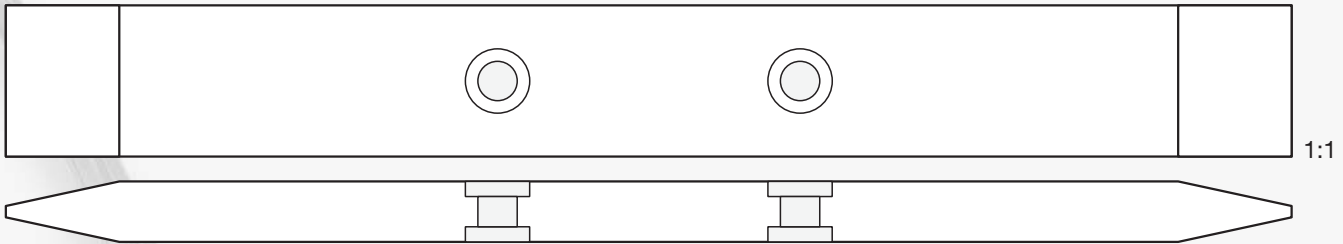

**ART. P219**

PIASTRINA APRIPINZA TRAENTE/OPENER BLADE

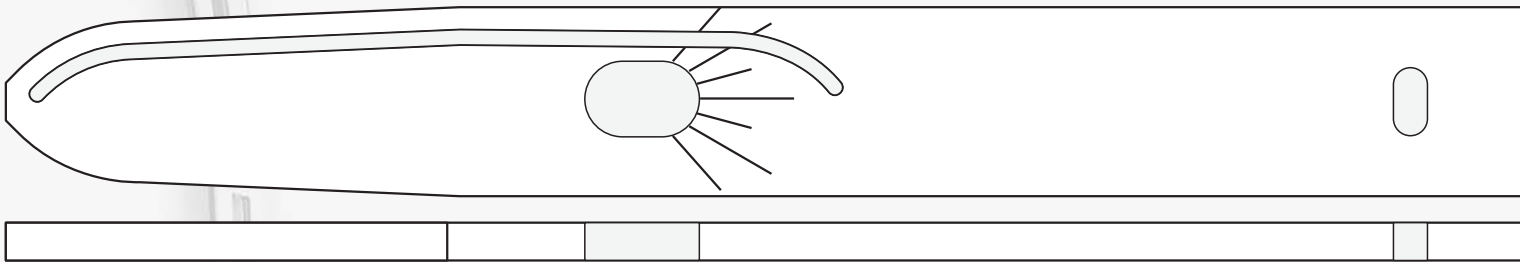

**ART. P223**

PIASTRA APRIPINZA/OPENER BLADE

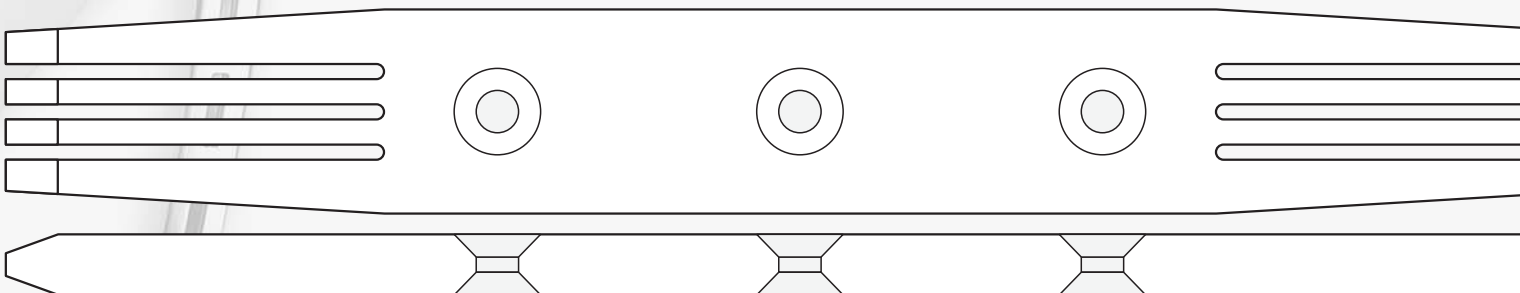

**ART. P224**

PIASTRINA APRIPINZA TRAENTE/OPENER BLADE

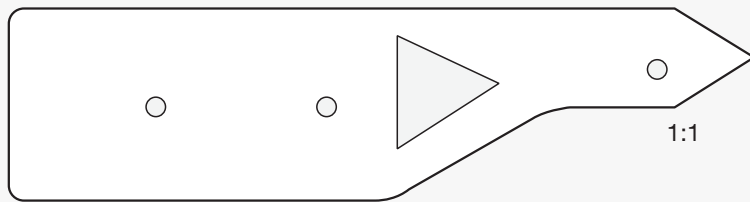

**ART. P240**

PIASTRINA PER PUNTA NASTRO/POINT PROTECTION

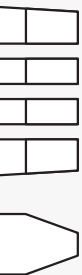
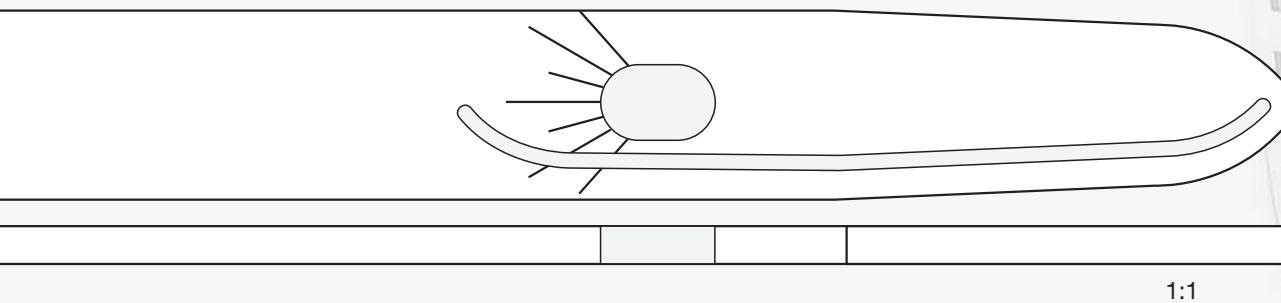

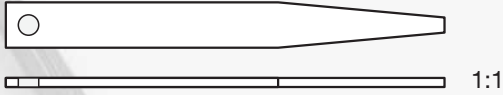

**ART. P226**

LAMINA DI PRESSIONE SUPERIORE/UPPER BLADE



**ART. P231**

LAMINA DI TRAZIONE/OPENER SPRING



**ART. P225**

LAMINA DI PRESSIONE INFERIORE/LOWER BLADE

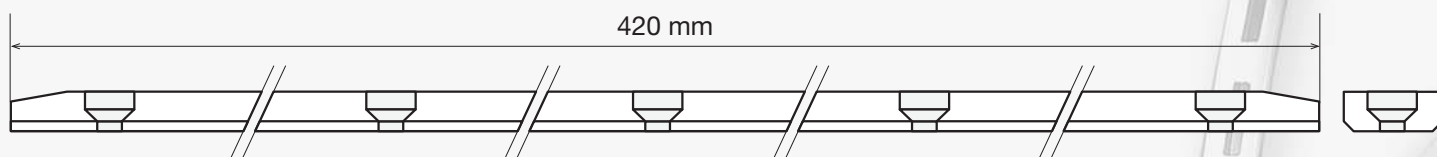

**ART. P227**

PIATTO DI REAZIONE/SUPPORT BAR

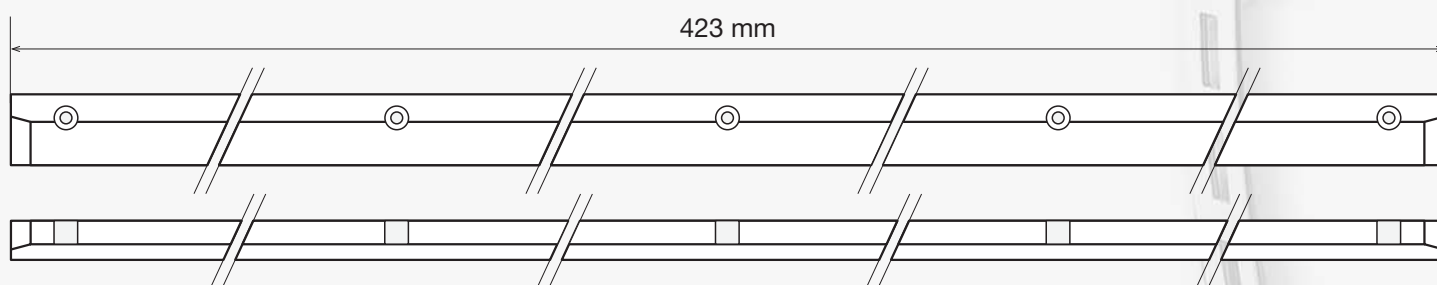

**ART. P229**

REAZIONE PER PINZA/GRIPPER SUPPORT

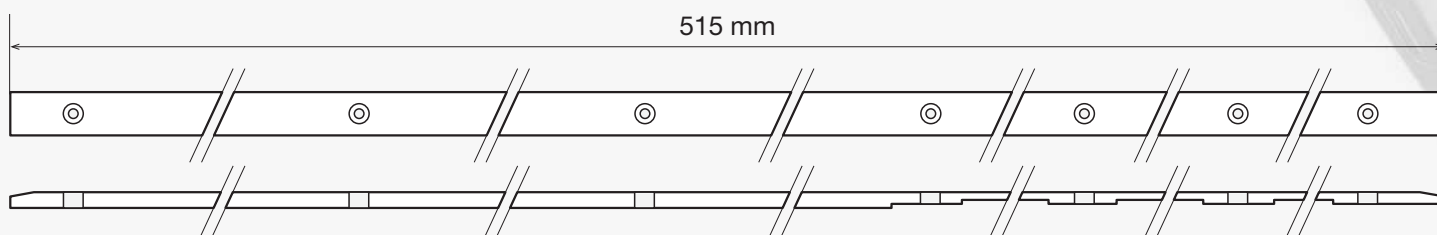

**ART. P230**

PIATTO DI SOSTEGNO/SUPPORT BAR

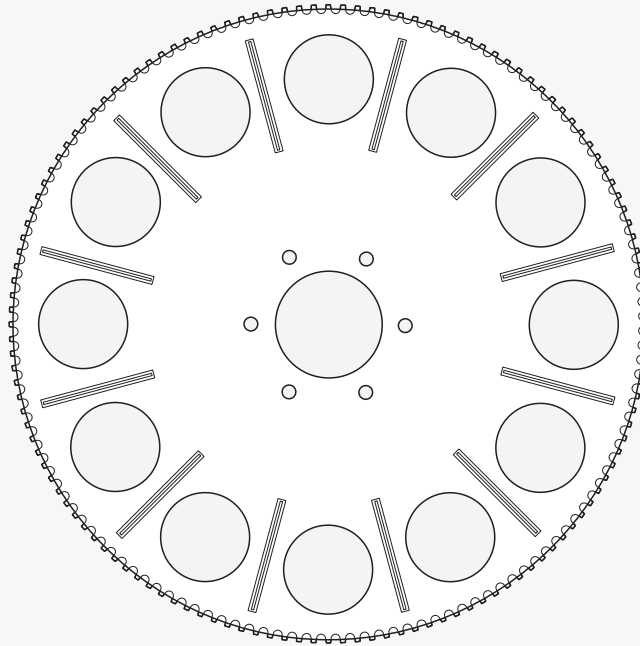
**ART. R004A# 136 M**

RUOTA DENTATA PER NASTRI TIPO LEONARDO/TOOTHED WHEEL FOR LEONARDO TYPE TAPES





## Nastri originali Lamiflex adatti per telai tipo Panter

Original Lamiflex flexible tapes suitable for Panter type looms

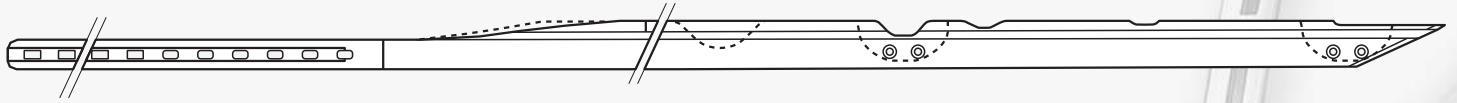

<b>ART. N256</b>	Lunghezza nastro Tape length	Codice Lamiflex Lamiflex Code
DX/RIGHT	2274 mm	N256 2274
	2398 mm	N256 2398
PINZA NEGATIVA NEGATIVE GRIPPER	3130 mm	N256 3130
	3255 mm	N256 3255

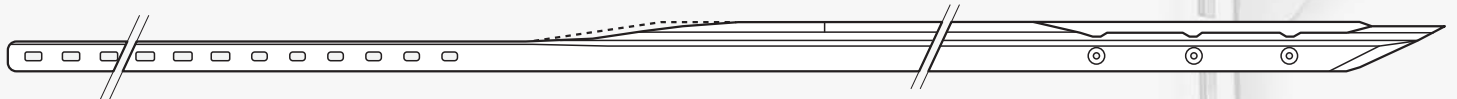

<b>ART. N256</b>	Lunghezza nastro Tape length	Codice Lamiflex Lamiflex Code
SX/LEFT	2274 mm	N256 2274
	2398 mm	N256 2398
PINZA NEGATIVA NEGATIVE GRIPPER	3130 mm	N256 3130
	3255 mm	N256 3255



<b>ART. N257</b>	Lunghezza nastro Tape length	Codice Lamiflex Lamiflex Code
DX/RIGHT	2283 mm	N257 2283
	3233 mm	N257 3233
PINZA POSITIVA POSITIVE GRIPPER		

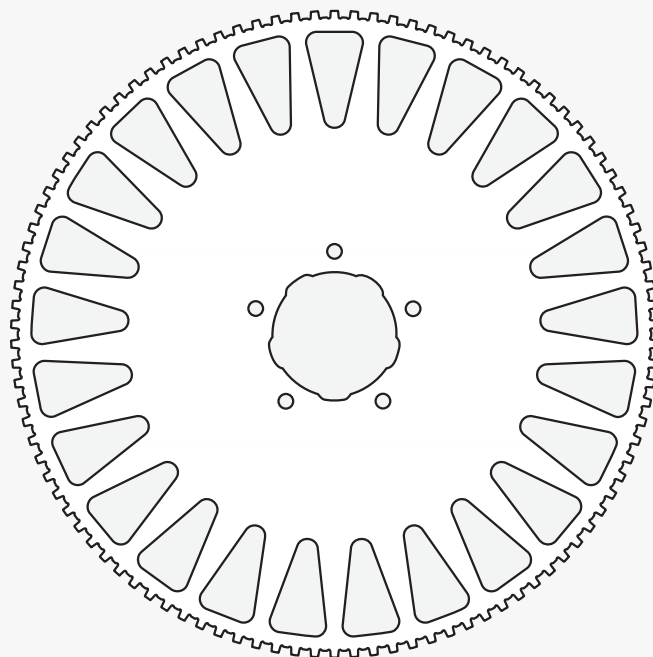

<b>ART. N257</b>	Lunghezza nastro Tape length	Codice Lamiflex Lamiflex Code
SX/LEFT	2280 mm	N257 2280
	3230 mm	N257 3230
PINZA POSITIVA POSITIVE GRIPPER		

**ART. R030#&**

RUOTA DENTATA Ø 313 mm/THOOTHED WHEEL Ø 313 mm



## Nastri originali Lamiflex adatti per telai tipo Picanol

Original Lamiflex flexible tapes suitable for Picanol type looms

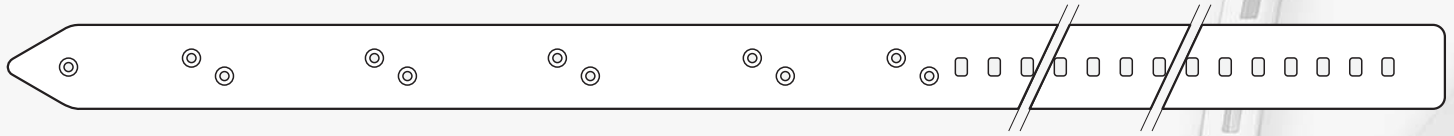

<b>ART. N301</b>	Telaio/Loom GTM	Lungh. nastro Tape length	Codice Lamiflex Lamiflex Code	Variante Variant
DX/RIGHT	190	2161 mm	N301 2161	CC Con carbonio - With carbon
	220-240	2631 mm	N301 2631	SC Senza carbonio - Without carbon
	280	2948 mm	N301 2948	

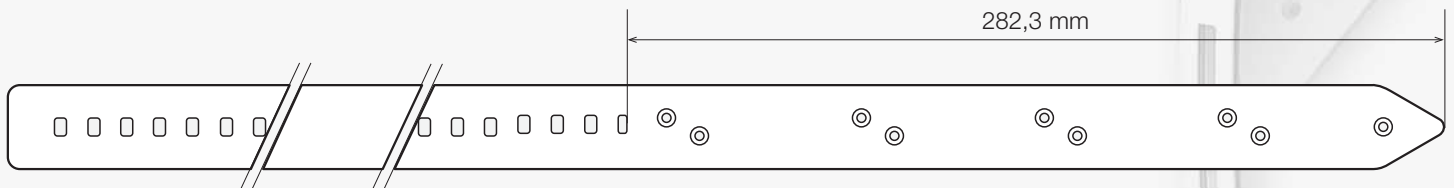

<b>ART. N302</b>	Telaio/Loom GTM	Lungh. nastro Tape length	Codice Lamiflex Lamiflex Code	Variante Variant
SX/LEFT	190	2174 mm	N302 2174	CC Con carbonio - With carbon
	220-240	2631 mm	N302 2631	SC Senza carbonio - Without carbon
	280	2961 mm	N302 2961	



<b>ART. N303</b>	Telaio/Loom GTM	Lungh. nastro Tape length	Codice Lamiflex Lamiflex Code	Variante Variant
DX/RIGHT	190	2161 mm	N303 2161	CC Con carbonio - With carbon
	220-240	2631 mm	N303 2631	SC Senza carbonio - Without carbon
	280	2948 mm	N303 2948	

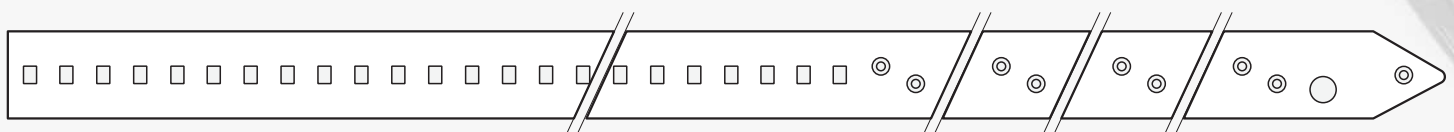

<b>ART. N304</b>	Telaio/Loom GTM	Lungh. nastro Tape length	Codice Lamiflex Lamiflex Code	Variante Variant
SX/LEFT	190	2174 mm	N304 2174	CC Con carbonio - With carbon
	220-240	2631 mm	N304 2631	SC Senza carbonio - Without carbon
	280	2961 mm	N304 2961	

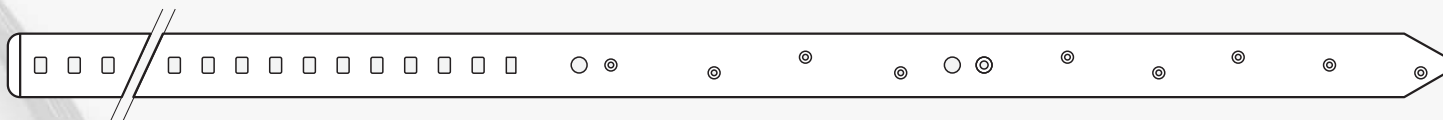

<b>ART. N305</b>	Telaio/Loom GTM-AS	Lungh. nastro Tape length	Codice Lamiflex Lamiflex Code
SX/LEFT	190	2218 mm	N305 2218 C1
	220-240	2574 mm	N305 2574 C2
	280	2904 mm	N305 2904 C2

<b>ART. N305/A</b>	Telaio/Loom GTM-AS	Lungh. nastro Tape length	Codice Lamiflex Lamiflex Code
SX/LEFT	190	2155 mm	N305/A 2155 C2

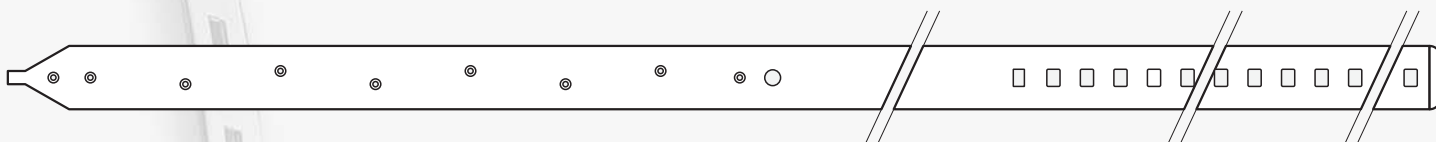

<b>ART. N325</b>	Telaio/Loom GTM-AS	Lungh. nastro Tape length	Codice Lamiflex Lamiflex Code
DX/RIGHT	190	2193 mm	N325 2193 C2
	220-240	2612 mm	N325 2612 C2
	280	2943 mm	N325 2943 C2

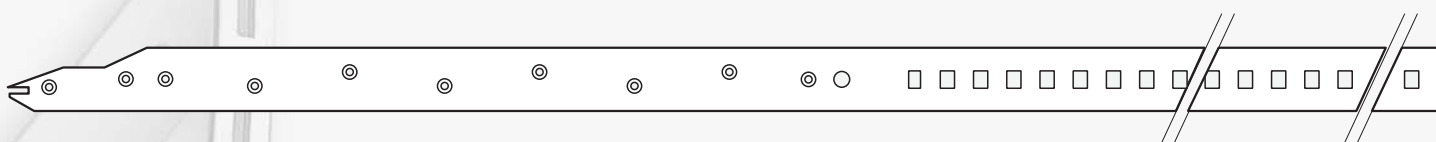

<b>ART. N306</b>	Telaio/Loom GTM-AS	Lungh. nastro Tape length	Codice Lamiflex Lamiflex Code
DX/RIGHT	190	2269 mm	N306 2269 C1
	220-240	2637 mm	N306 2637 C2
	280	2967 mm	N306 2967 C2

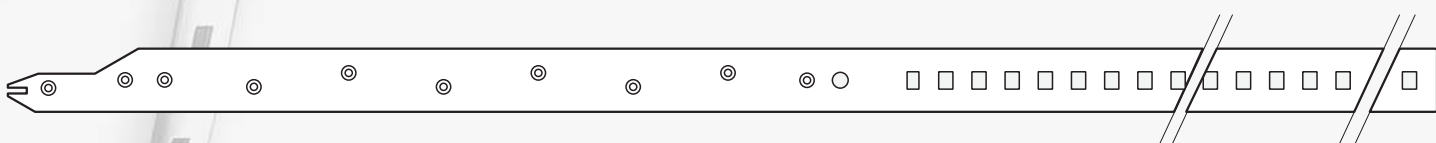

<b>ART. N324</b>	Telaio/Loom GTM-AS	Lungh. nastro Tape length	Codice Lamiflex Lamiflex Code
DX/RIGHT	190	2218 mm	N324 2218 C2
	220-240	2637 mm	N324 2637 C2
	280	2967 mm	N324 2967 C2

## Nastri originali Lamiflex adatti per telai tipo Picanol

Original Lamiflex flexible tapes suitable for Picanol type looms

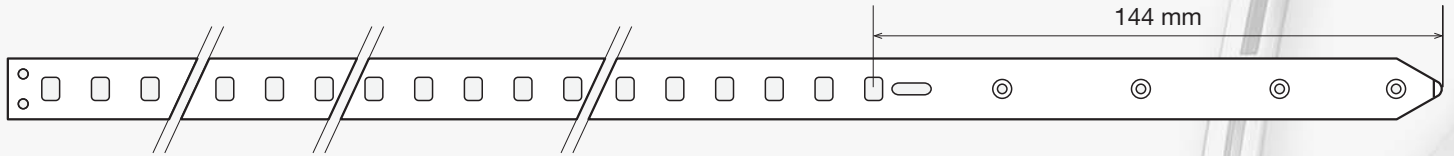

<b>ART. N336</b> SX/LEFT	Telaio/Loom GAMMA	Lungh. nastro Tape length	Codice Lamiflex Lamiflex Code
	190	1704 mm	N336 1704 FN

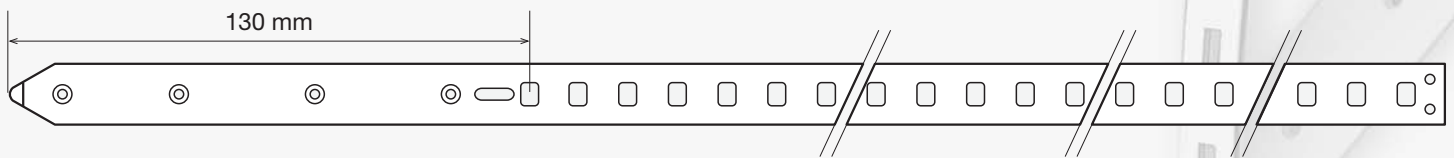

<b>ART. N337</b> DX/RIGHT	Telaio/Loom GAMMA	Lungh. nastro Tape length	Codice Lamiflex Lamiflex Code
	190	1728 mm	N337 1728 FN

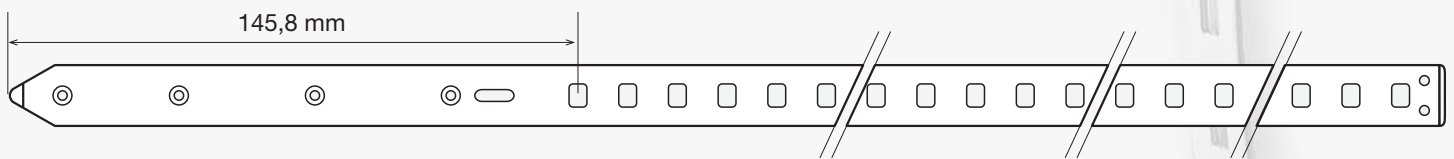

<b>ART. N337 A</b> DX/RIGHT	Telaio/Loom GAMMA	Lungh. nastro Tape length	Codice Lamiflex Lamiflex Code
	190	1743 mm	N337A 1743 FN

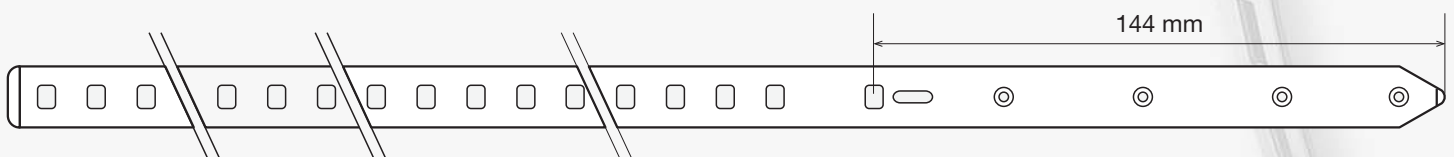

<b>ART. N338</b> SX/LEFT	Telaio/Loom GAMMA	Lungh. nastro Tape length	Codice Lamiflex Lamiflex Code
	220	2580 mm	N338 2580 FN
	250	2735 mm	N338 2735 FN
	300	2974 mm	N338 2974 FN
	340	3177 mm	N338 3177 FN

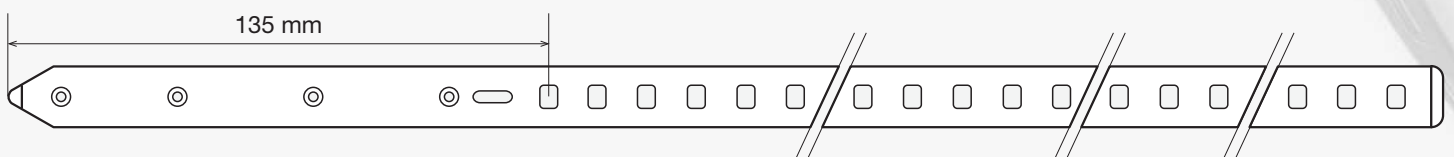

<b>ART. N339</b> DX/RIGHT	Telaio/Loom GAMMA	Lungh. nastro Tape length	Codice Lamiflex Lamiflex Code
	220	2608 mm	N339 2608 FN
	250	2764 mm	N339 2764 FN
	300	3003 mm	N339 3003 FN
	340	3219 mm	N339 3219 FN

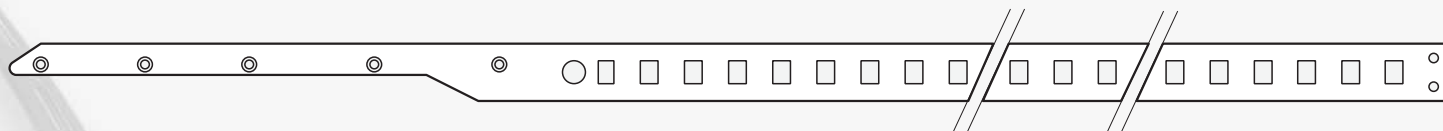

<b>ART. N307</b> DX/RIGHT	Telaio/Loom GAMMA	Lungh. nastro Tape length	Codice Lamiflex Lamiflex Code
	190	1769 mm	N307 1769

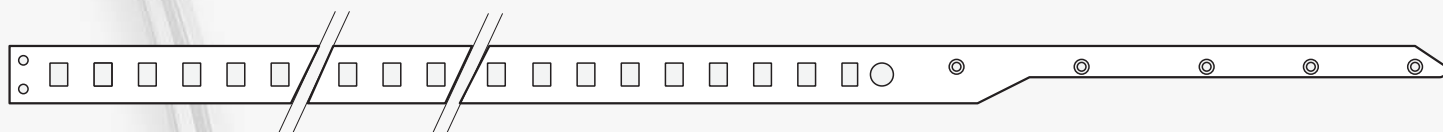

<b>ART. N308</b> SX/LEFT	Telaio/Loom GAMMA	Lungh. nastro Tape length	Codice Lamiflex Lamiflex Code
	190	1732 mm	N308 1732

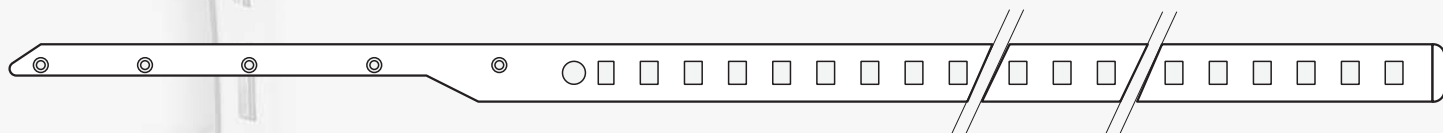

<b>ART. N309</b> DX/RIGHT	Telaio/Loom GAMMA	Lungh. nastro Tape length	Codice Lamiflex Lamiflex Code
	220	2649 mm	N309 2649
	250	2802 mm	N309 2802
	300	3043 mm	N309 3043
	340	3259 mm	N309 3259
	380	3437 mm	N309 3437

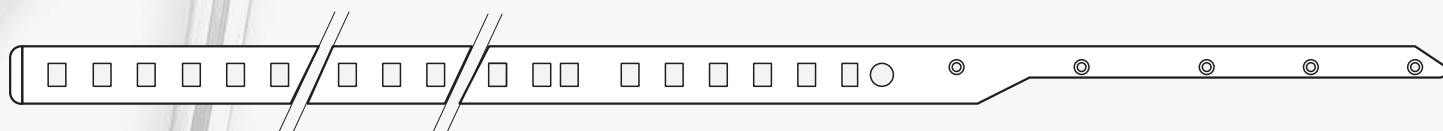

<b>ART. N310</b> SX/LEFT	Telaio/Loom GAMMA	Lungh. nastro Tape length	Codice Lamiflex Lamiflex Code
	220	2612 mm	N310 2612
	250	2764 mm	N310 2764
	300	3006 mm	N310 3006
	340	3209 mm	N310 3209
	380	3412 mm	N310 3412

## Nastri originali Lamiflex adatti per telai tipo Picanol

Original Lamiflex flexible tapes suitable for Picanol type looms

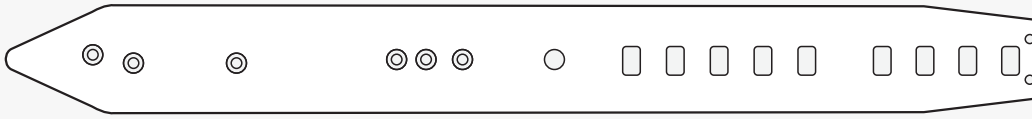

<b>ART. N355</b>	Telaio/Loom GAMMAX	Lungh. nastro Tape length	Codice Lamiflex Lamiflex Code
SX/LEFT	190	1808 mm	N355 1808
	210	2668 mm	N355 2668
	220	2711 mm	N355 2711
	230	2767 mm	N355 2767
	250	2864 mm	N355 2864
	300	3113 mm	N355 3113
	320	3214 mm	N355 3214
	340	3322 mm	N355 3322

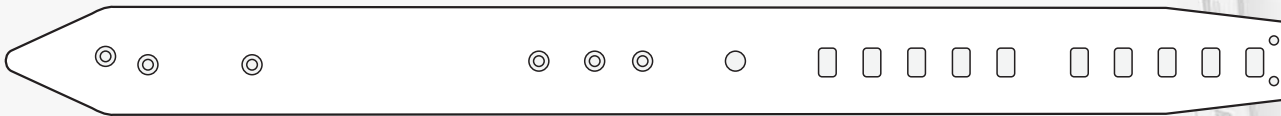

<b>ART. N356</b>	Telaio/Loom GAMMAX	Lungh. nastro Tape length	Codice Lamiflex Lamiflex Code
DX/RIGHT	190	1846 mm	N356 1846
	220	2737 mm	N356 2737
	250	2890 mm	N356 2890
	300	3138 mm	N356 3138
	340	3348 mm	N356 3348

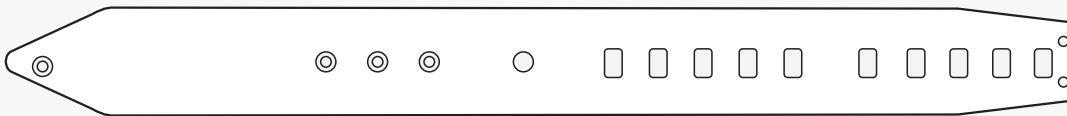

<b>ART. N357</b>	Telaio/Loom GAMMAX	Lungh. nastro Tape length	Codice Lamiflex Lamiflex Code
DX/RIGHT	190	1796 mm	N357 1796
	210	2643 mm	N357 2643
	220	2687 mm	N357 2687
	230	2742 mm	N357 2742
	250	2840 mm	N357 2840
	300	3088 mm	N357 3088
	320	3189 mm	N357 3189
	340	3298 mm	N357 3298

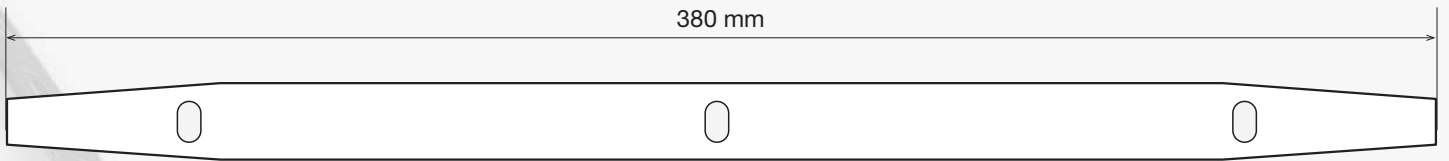

**ART. P305**

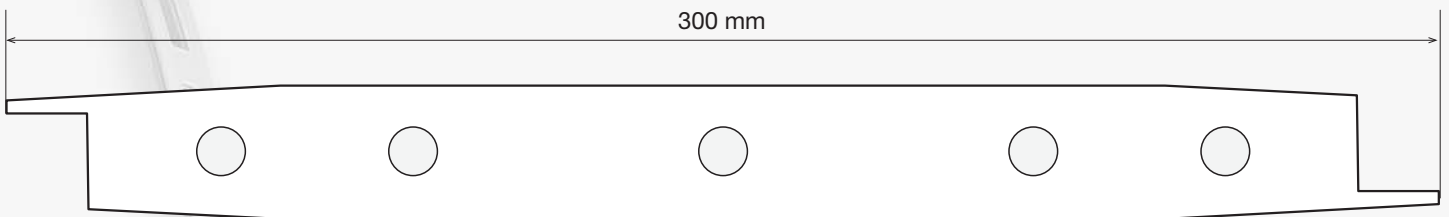

**ART. P307**

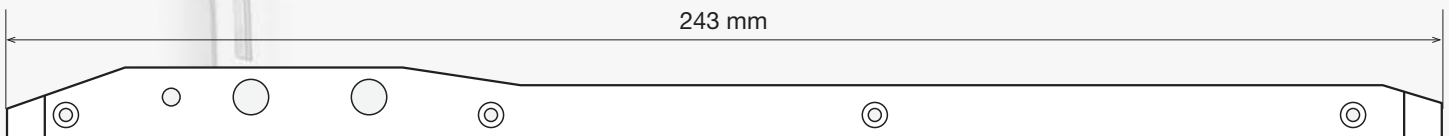

**ART. P311**

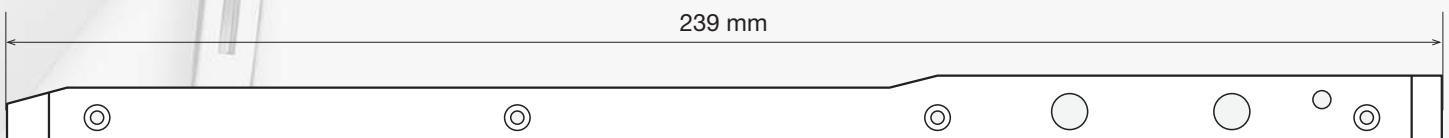

**ART. P312**



**ART. P313**



Particolari originali Lamiflex adatti per telai tipo **Picanol**

Original Lamiflex accessories suitable for **Picanol** type looms

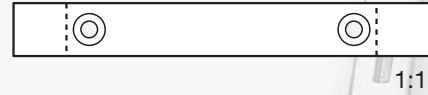

**ART. P314**

**ART. P315**

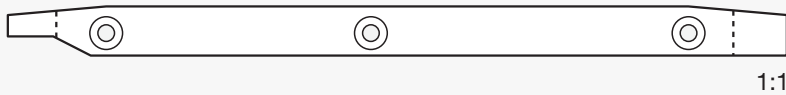

**ART. P316**

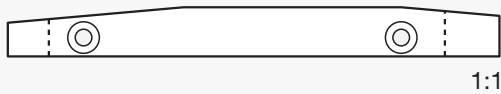

**ART. P317**



**ART. P320**

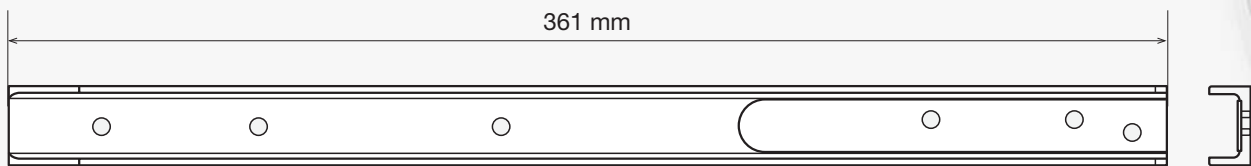

**ART. C037**

SUPPORTO IN CARBONIO SX/CARBON SUPPORT LEFT

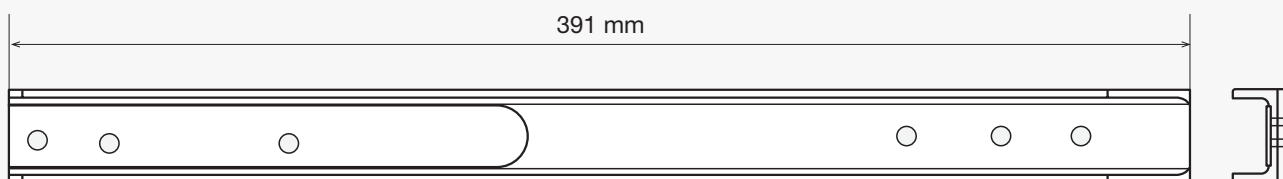

**ART. C038**

SUPPORTO IN CARBONIO DX/CARBON SUPPORT RIGHT

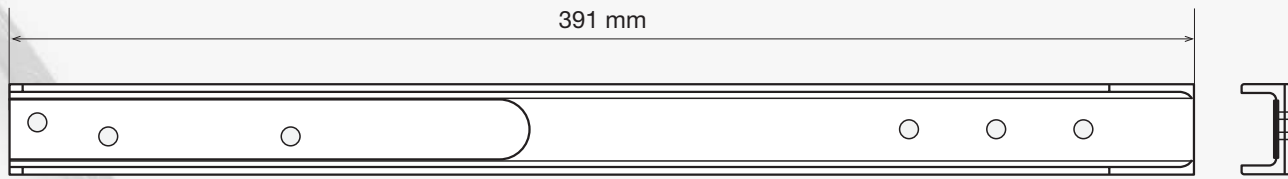
**ART. C039**

SUPPORTO IN CARBONIO DX/CARBON SUPPORT RIGHT

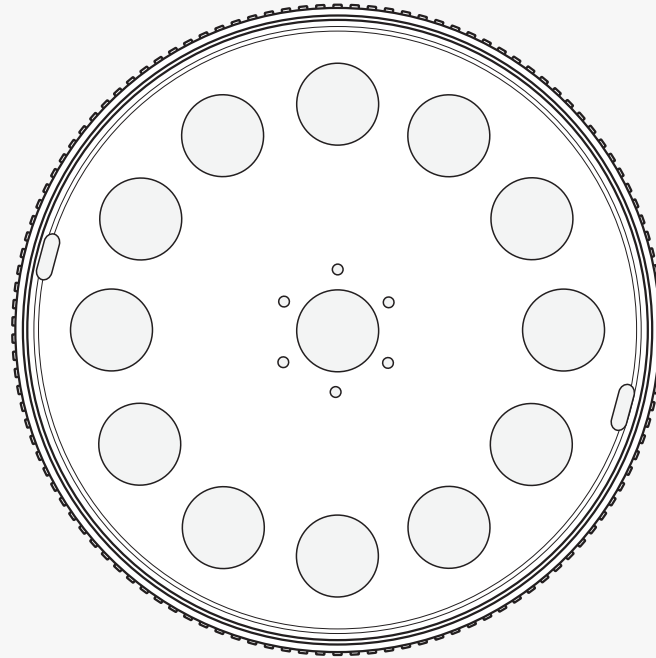
**ART. R021# VET CD T1 &**

RUOTA DENTATA IN COMPOSITO/COMPOSITE TOOTHED WHEEL



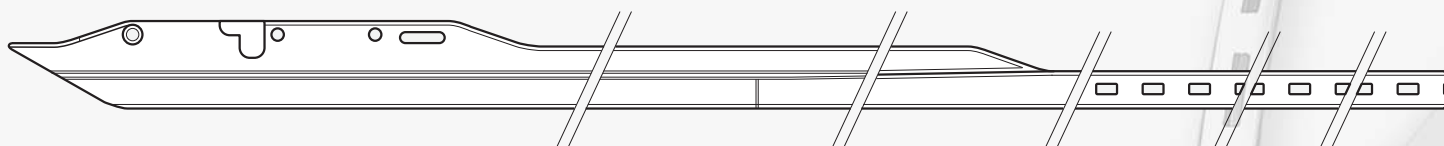

<b>ART. N366</b>	Telaio/Loom OPTIMAX	Lungh. nastro Tape length	Codice Lamiflex Lamiflex Code
DX/RIGHT	190	2498 mm	N366 2498
	220	2655 mm	N366 2655
	230/250	2798 mm	N366 2620
	300/380	3448 mm	N366 2798
	400/460	3928 mm	N366 3928

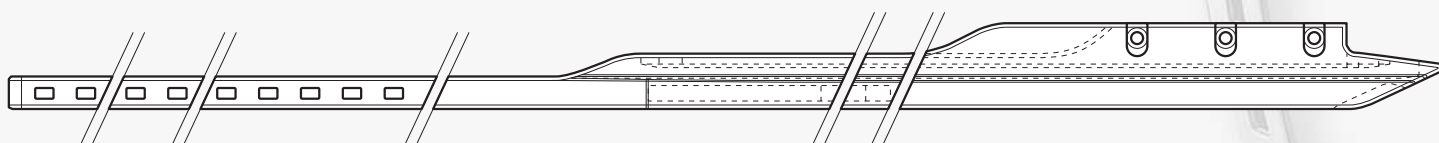

<b>ART. N367</b>	Telaio/Loom OPTIMAX	Lungh. nastro Tape length	Codice Lamiflex Lamiflex Code
SX/LEFT	190	2498 mm	N367 2498
	220	2655 mm	N367 2655
	230/250	2798 mm	N367 2620
	300/380	3448 mm	N367 2798
	400/460	3928 mm	N367 3928

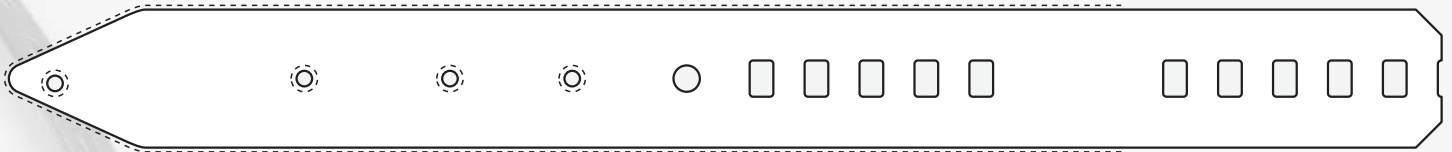

ART. N368	Telaio/Loom OPTIMAX	Lungh. nastro Tape length	Codice Lamiflex Lamiflex Code
DX/RIGHT	190	2393 mm	N368 2393
	230	2599 mm	N368 2599
	250	2696 mm	N368 2696
	320	3043 mm	N368 3043
	360	3249 mm	N368 3249

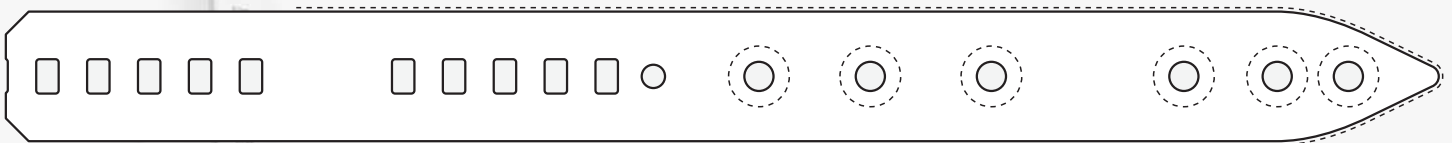

ART. N369	Telaio/Loom OPTIMAX	Lungh. nastro Tape length	Codice Lamiflex Lamiflex Code
SX/LEFT	190	2447 mm	N369 2447
	230	2653 mm	N369 2653
	250	2751 mm	N369 2751
	320	3097 mm	N369 3097
	360	3303 mm	N369 3303

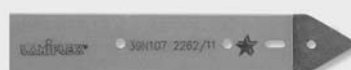

## Nastri originali Lamiflex adatti per telai tipo Smit

Original Lamiflex flexible tapes suitable for Smit type looms

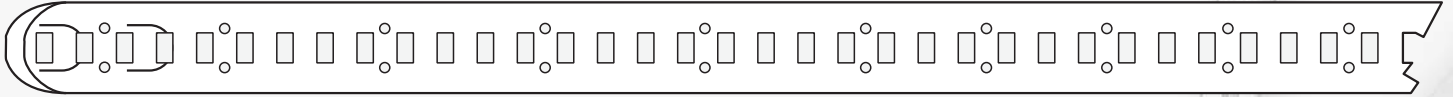

<b>ART. N401</b>	Telaio/Loom TP 300-TP 400	Lungh. nastro Tape length	Codice Lamiflex Lamiflex Code
DX-SX/RIGHT-LEFT	190	1620 mm	N401 1620
	210	1720 mm	N401 1720
	230	1818 mm	N401 1818
	250	1916 mm	N401 1916
	290	2120 mm	N401 2120
	330	2316 mm	N401 2316
	360	2468 mm	N401 2468
	410	3000 mm	N401 3000
	550	3868 mm	N401 3868

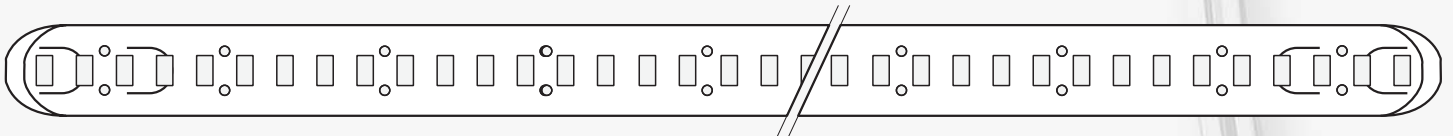

<b>ART. N402</b>	Telaio/Loom TP 300	Lungh. nastro Tape length	Codice Lamiflex Lamiflex Code
DX-SX/RIGHT-LEFT	210	2010 mm	N402 2010
	250	2213 mm	N402 2213
FINITO DA AMBO LE PARTI FINISHED ON BOTH SIDES	330	2620 mm	N402 2620
	360	2766 mm	N402 2766
	410	3016 mm	N402 3016

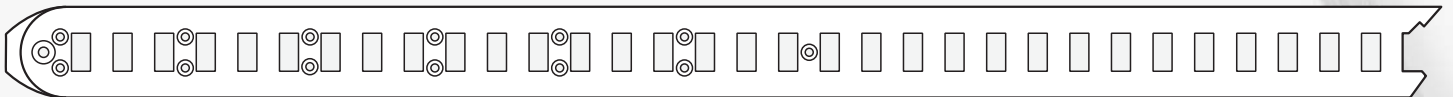

<b>ART. N403</b>	Telaio/Loom TP 300-TP 400	Lungh. nastro Tape length	Codice Lamiflex Lamiflex Code
DX-SX/RIGHT-LEFT	200	1655 mm	N403 1655
	220	1752 mm	N403 1752
PINZA VERTICALE VERTICAL GRIPPER	240	1850 mm	N403 1850
	260	1948 mm	N403 1948
	290	2154 mm	N403 2154
	330	2348 mm	N403 2348
	360	2500 mm	N403 2500
	410	2748 mm	N403 2748



<b>ART. N404</b>	Telaio/Loom TP 500	Lungh. nastro Tape length	Codice Lamiflex Lamiflex Code
DX-SX/RIGHT-LEFT	200	2200 mm	N404 2200
	220	2310 mm	N404 2310
	240	2418 mm	N404 2418
	260	2505 mm	N404 2505
	290	2700 mm	N404 2700
	330	2895 mm	N404 2895
	360	3047 mm	N404 3047
	380	3265 mm	N404 3265
	440	3612 mm	N404 3612

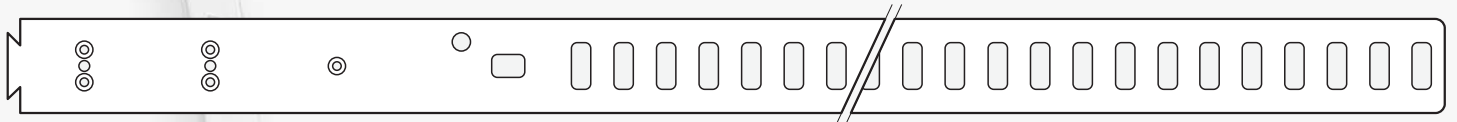

<b>ART. N409</b>	Telaio/Loom TP 500	Lungh. nastro Tape length	Codice Lamiflex Lamiflex Code
DX-SX/RIGHT-LEFT	200	2075 mm	N409 2075
	220	2185 mm	N409 2185
	240	2293 mm	N409 2293
	260	2380 mm	N409 2380
	290	2575 mm	N409 2575
	330	2770 mm	N409 2770
	360	2922 mm	N409 2922
	380	3140 mm	N409 3140
	440	3487 mm	N409 3487

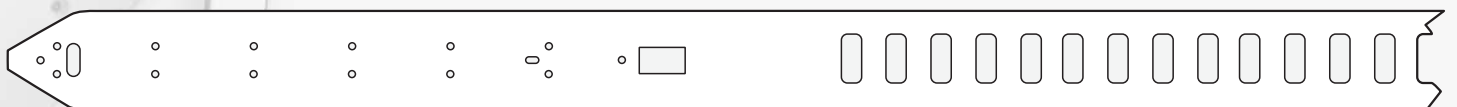

<b>ART. N405</b>	Telaio/Loom TP 600	Lungh. nastro Tape length	Codice Lamiflex Lamiflex Code
DX-SX/RIGHT-LEFT	200	2200 mm	N405 2200
	220	2310 mm	N405 2310
	240	2418 mm	N405 2418
	260	2505 mm	N405 2505
	290	2700 mm	N405 2700
	330	2895 mm	N405 2895
	360	3047 mm	N405 3047
	380	3265 mm	N405 3265
	440	3612 mm	N405 3612

## Nastri originali Lamiflex adatti per telai tipo Smit

Original Lamiflex flexible tapes suitable for Smit type looms

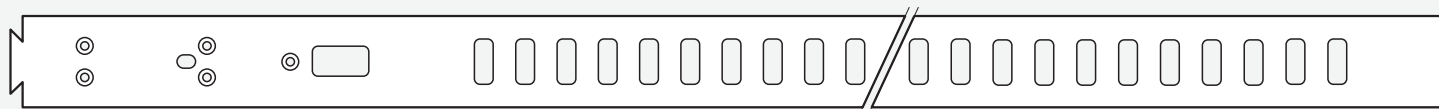

<b>ART. N407</b>	Telaio/Loom TP 600	Lungh. nastro Tape length	Codice Lamiflex Lamiflex Code
DX-SX/RIGHT-LEFT	200	2075 mm	N407 2075
	220	2185 mm	N407 2185
	240	2293 mm	N407 2293
	260	2380 mm	N407 2380
	290	2575 mm	N407 2575
	330	2770 mm	N407 2770
	360	2922 mm	N407 2922
	380	3140 mm	N407 3140
	440	3487 mm	N407 3487

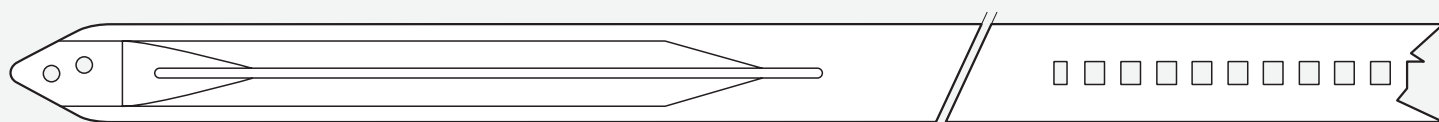

<b>ART. N406</b>	Telaio/Loom FAST	Lungh. nastro Tape length	Codice Lamiflex Lamiflex Code
DX-SX/RIGHT-LEFT	170	2510 mm	N406 2510
	190	2608 mm	N406 2608
	200	2650 mm	N406 2650
	220	2748 mm	N406 2748
	240	2846 mm	N406 2846
	260	2944 mm	N406 2944
	290	3150 mm	N406 3150
	320	3355 mm	N406 3355
	340	3450 mm	N406 3450
	360	3550 mm	N406 3550

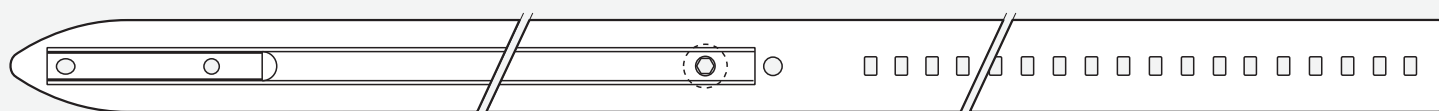

<b>ART. N410</b>	Telaio/Loom G 6300	Lungh. nastro Tape length	Codice Lamiflex Lamiflex Code
DX-SX/RIGHT-LEFT	170	2532 mm	N410 2532
	190	2630 mm	N410 2630
	200	2672 mm	N410 2672
	220	2770 mm	N410 2770
	230	2822 mm	N410 2822
	240	2868 mm	N410 2868
	260	2966 mm	N410 2966
	290	3172 mm	N410 3172
	320	3377 mm	N410 3377
	340	3472 mm	N410 3472
	360	3572 mm	N410 3572

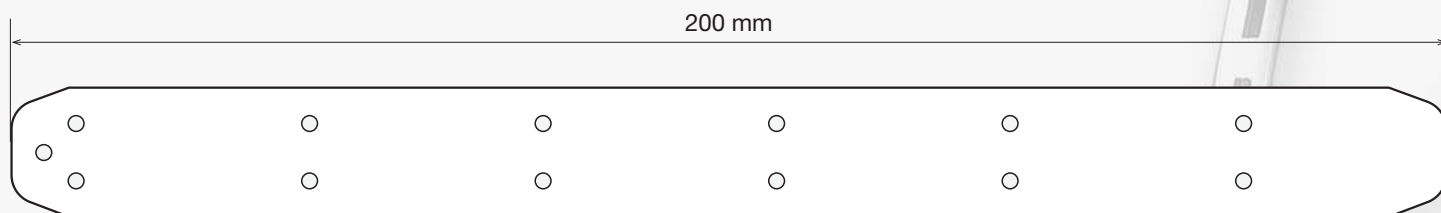

**ART. P407**

LISTA SOPRANASTRO/TAPE SUPPORT

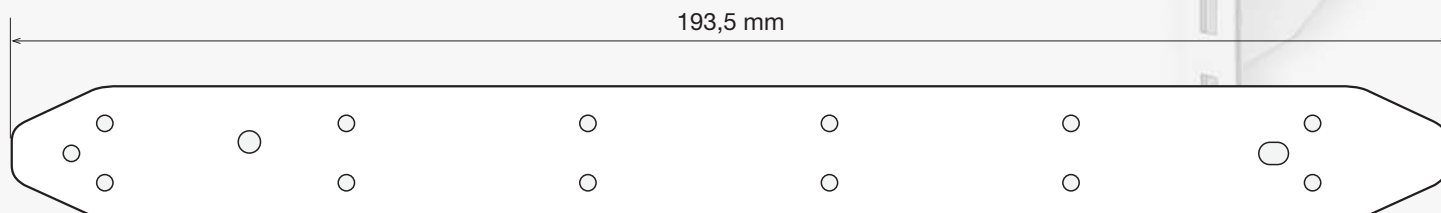

**ART. P408**

LISTA SOPRANASTRO/TAPE SUPPORT

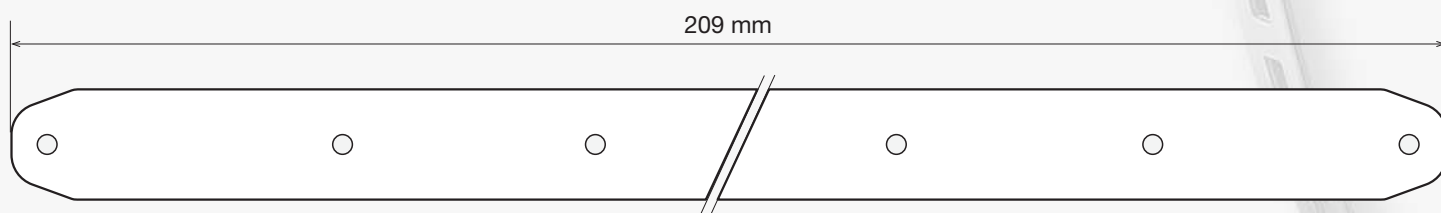

**ART. P510**

LISTA SOTTONASTRO/TAPE SUPPORT

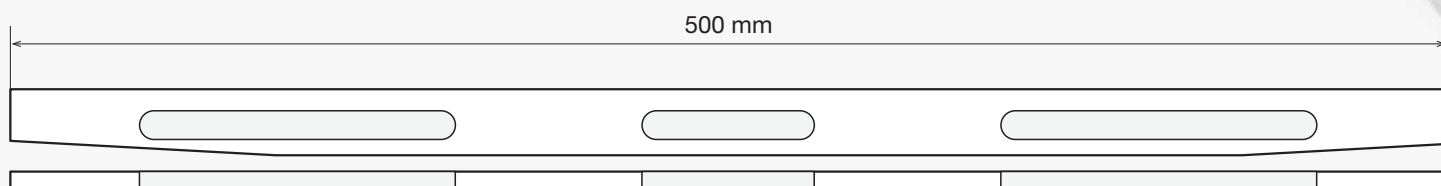

**ART. P411**

LISTA SGANCIATRAMA/OPENER



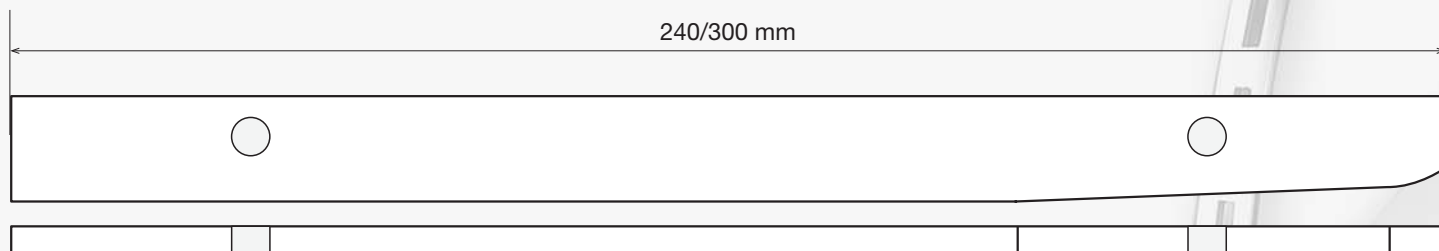

**ART. P412**

LISTA APRIPINZA/OPENER

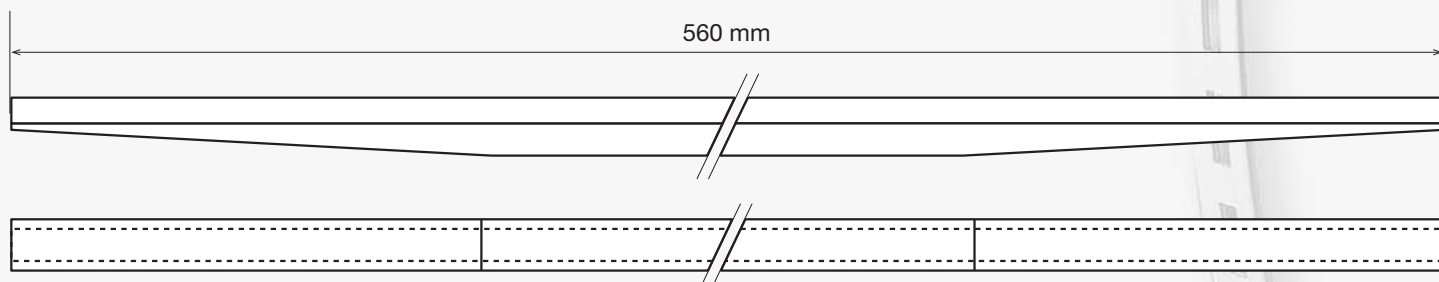

**ART. P413**

LISTA SGANCIATRAMA/OPENER

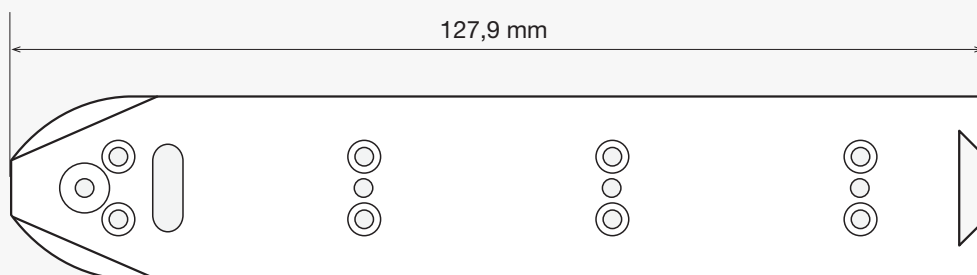

**ART. P416**

PUNTA NASTRO TP 500/TAPE POINT FOR TP 500

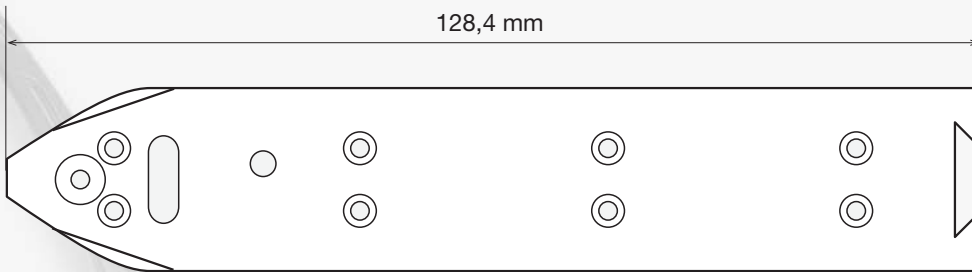

**ART. P417**

PUNTA NASTRO TP 600/TAPE POINT FOR TP 600



**ART. P419**

SUPPORTO PINZA/GRIPPER SUPPORT

**ART. P420**

SUPPORTO PINZA/GRIPPER SUPPORT

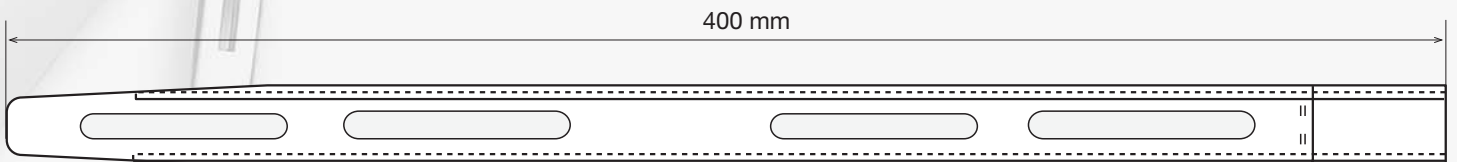

**ART. P851 LP FN**

LISTA SGANCIATRAMA/OPENER



## Nastri originali Lamiflex adatti per telai tipo Sultex

Original Lamiflex flexible tapes suitable for Sultex type looms

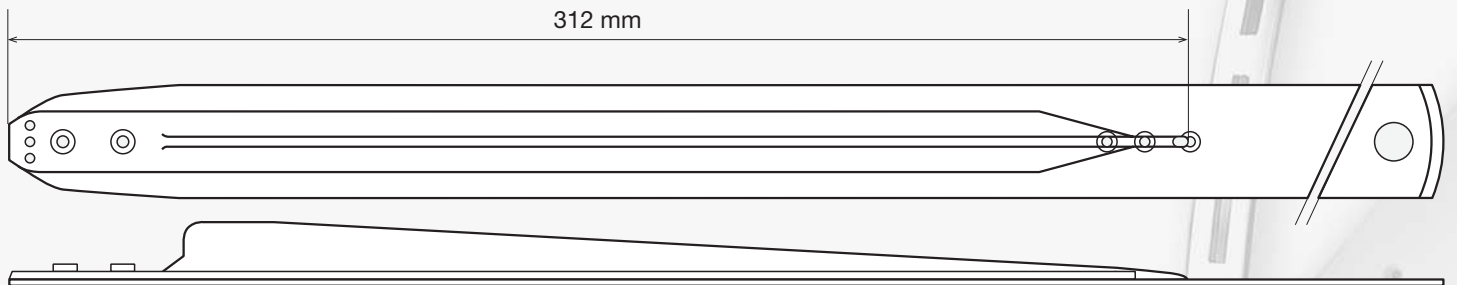

<b>ART. N501</b>	Telaio/Loom F 2001	Lungh. nastro Tape length	Codice Lamiflex Lamiflex Code	Variante Variant
DX/RIGHT	140-160	1592 mm	N501 1592	<b>CA</b> In carbonio - In carbon (spessore - thickness 1,3 mm)  <b>K</b> In kevlar (spessore - thickness 1,6 mm)
	170-190	1675 mm	N501 1675	
	170-190	1710 mm	N501 1710	
	200-220	1860 mm	N501 1860	
	230-250	2025 mm	N501 2025	
	260-280	2182 mm	N501 2182	

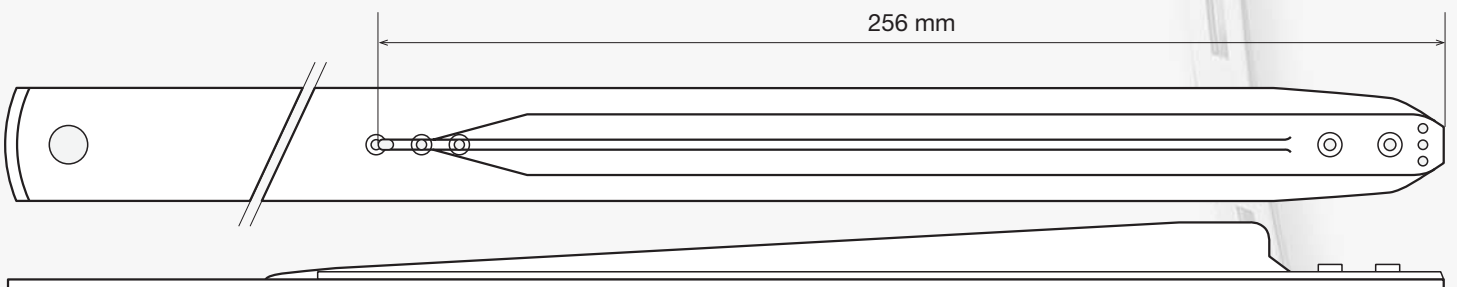

<b>ART. N502</b>	Telaio/Loom F 2001	Lungh. nastro Tape length	Codice Lamiflex Lamiflex Code	Variante Variant
SX/LEFT	140-160	1542 mm	N502 1542	<b>CA</b> In carbonio - In carbon (spessore - thickness 1,3 mm)  <b>K</b> In kevlar (spessore - thickness 1,6 mm)
	170-190	1660 mm	N502 1660	
	200-220	1810 mm	N502 1810	
	230-250	1975 mm	N502 1975	
	260-280	2132 mm	N502 2132	
	290	2179 mm	N502 2179	

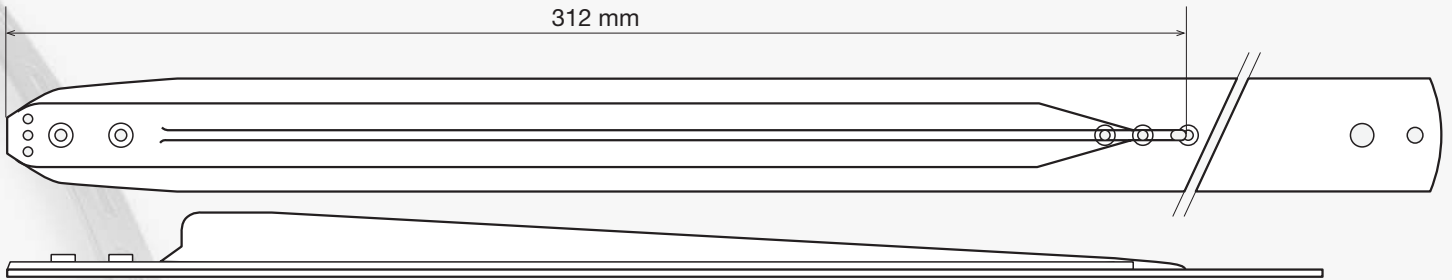

<b>ART. N504</b>	Telaio/Loom F 2001	Lungh. nastro Tape length	Codice Lamiflex Lamiflex Code	Variante Variant
DX/RIGHT	140-160	1619 mm	N504 1619	CA In carbonio - In carbon (spessore - thickness 1,3 mm)
	170-190	1769 mm	N504 1769	
	200-220	1919 mm	N504 1919	
	230-250	2069 mm	N504 2069	K In kevlar (spessore - thickness 1,6 mm)
	260-280	2219 mm	N504 2219	
	290	2269 mm	N504 2269	

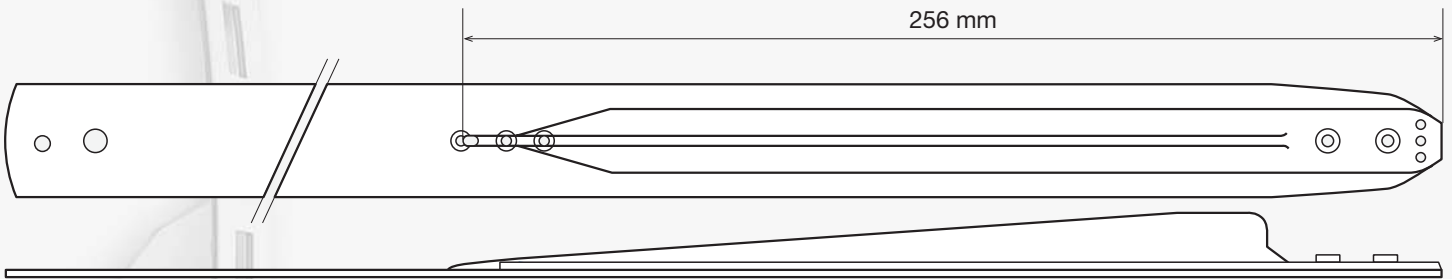

<b>ART. N505</b>	Telaio/Loom F 2001	Lungh. nastro Tape length	Codice Lamiflex Lamiflex Code	Variante Variant
SX/LEFT	140-160	1632 mm	N505 1632	CA In carbonio - In carbon (spessore - thickness 1,3 mm)
	170-190	1782 mm	N505 1782	
	200-220	1932 mm	N505 1932	
	230-250	2082 mm	N505 2082	K In kevlar (spessore - thickness 1,6 mm)
	260-280	2232 mm	N505 2232	
	290	2282 mm	N505 2282	

## Nastri originali Lamiflex adatti per telai tipo Sultex

Original Lamiflex flexible tapes suitable for Sultex type looms

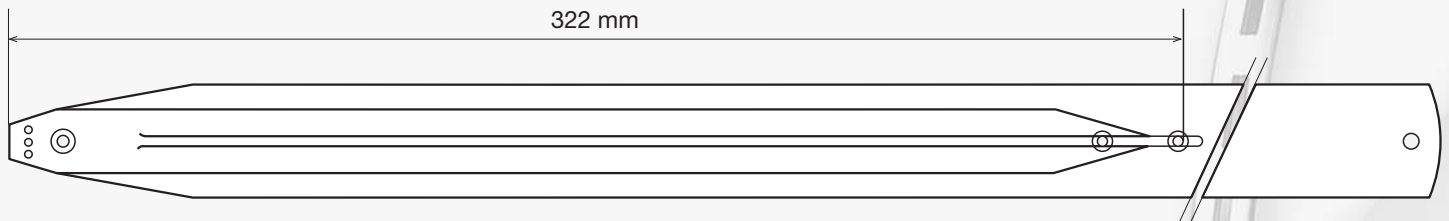

<b>ART. N506</b>	Telaio/Loom G 6100	Lungh. nastro Tape length	Codice Lamiflex Lamiflex Code	Variante Variant
DX/RIGHT	40-160	1663 mm	N506 1663	<b>CA</b> In carbonio - In carbon (spessore - thickness 1,3 mm)  <b>K</b> In kevlar (spessore - thickness 1,6 mm)
	170-190	1813 mm	N506 1813	
	200-220	1963 mm	N506 1963	
	230-250	2113 mm	N506 2113	
	260-280	2263 mm	N506 2263	
	290	2363 mm	N506 2363	

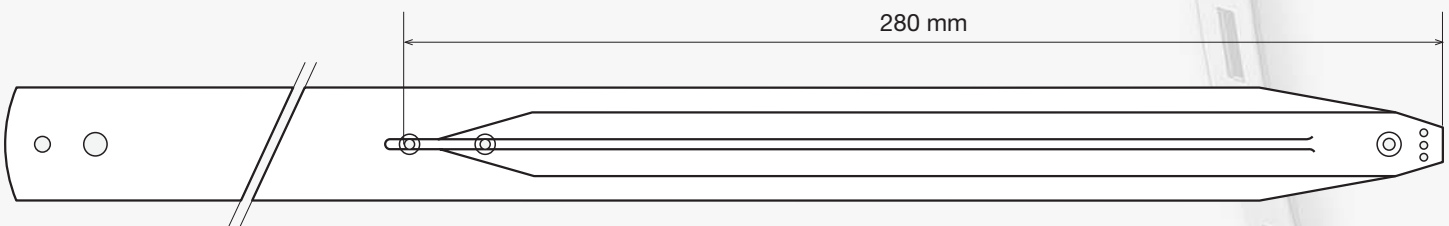

<b>ART. N507</b>	Telaio/Loom G 6100	Lungh. nastro Tape length	Codice Lamiflex Lamiflex Code	Variante Variant
SX/LEFT	140-180	1692 mm	N507 1692	<b>CA</b> In carbonio - In carbon (spessore - thickness 1,3 mm)
	190-210	1842 mm	N507 1842	
	220-250	2042 mm	N507 2042	
	260-290	2242 mm	N507 2242	

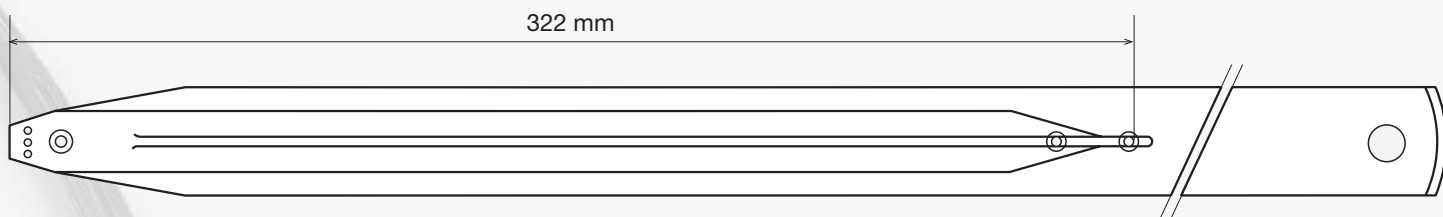

<b>ART. N508</b>	Telaio/Loom G 6100	Lungh. nastro Tape length	Codice Lamiflex Lamiflex Code	Variante Variant
DX-SX/RIGHT-LEFT	140-160	1638 mm	N508 1638	CA In carbonio - In carbon
	170-190	1756 mm	N508 1756	
	200-220	1906 mm	N508 1906	
	230-250	2071 mm	N508 2071	
	260-280	2228 mm	N508 2228	

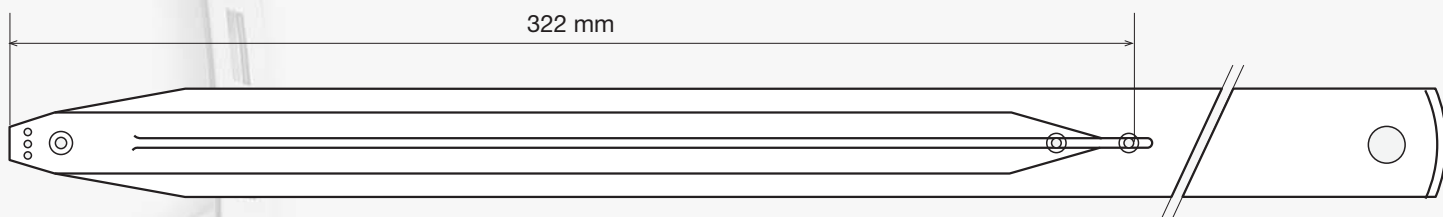

<b>ART. N509</b>	Telaio/Loom G 6100	Lungh. nastro Tape length	Codice Lamiflex Lamiflex Code	Variante Variant
DX/RIGHT	140-160	1638 mm	N509 1638	K In kevlar (spessore - thickness 1,6 mm)
	170-190	1756 mm	N509 1756	
	200-220	1906 mm	N509 1906	
	230-250	2071 mm	N509 2071	
	260-280	2228 mm	N509 2228	

<b>ART. N509</b>	Telaio/Loom G 6100	Lungh. nastro Tape length	Codice Lamiflex Lamiflex Code	Variante Variant
SX/LEFT	140-160	1573 mm	N509 1573	K In kevlar (spessore - thickness 1,6 mm)
	170-190	1691 mm	N509 1691	
	200-220	1841 mm	N509 1841	
	230-250	2006 mm	N509 2006	
	260-280	2163 mm	N509 2163	

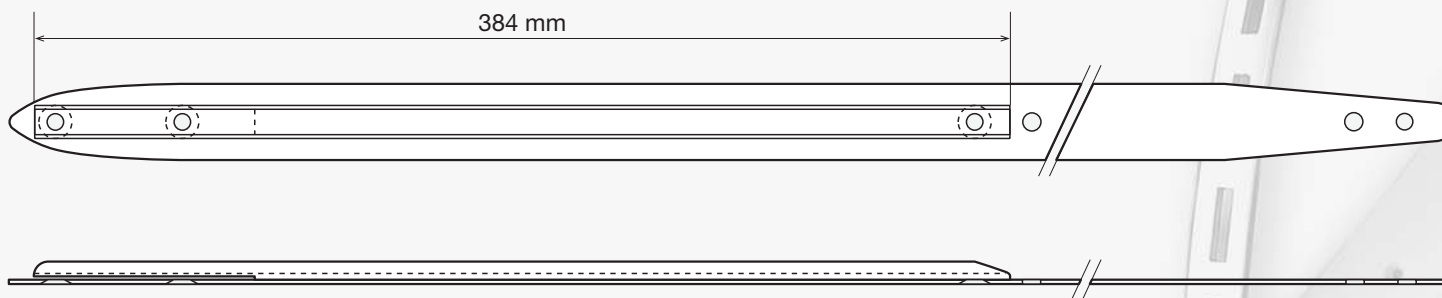

<b>ART. N510</b>	Telaio/Loom G 6200	Lungh. nastro Tape length	Codice Lamiflex Lamiflex Code	Variante Variant
DX-SX/RIGHT-LEFT	-	1884 mm	N510 1884	CA In carbonio - In carbon (spessore - thickness 1,1 mm)
	-	2134 mm	N510 2134	
	-	2434 mm	N510 2434	K In Kevlar (spessore - thickness 1,2 mm)
	-	2684 mm	N510 2684	

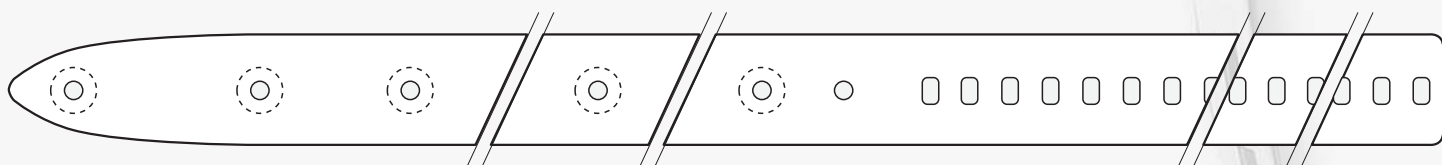

<b>ART. N519</b>	Telaio/Loom G 6500	Lungh. nastro Tape length	Codice Lamiflex Lamiflex Code
DX-SX/RIGHT-LEFT	-	2510 mm	N519 2510
	-	2763 mm	N519 2763
	-	2961 mm	N519 2961
	-	3060 mm	N519 3060
	-	3357 mm	N519 3357
	-	3467 mm	N519 3467

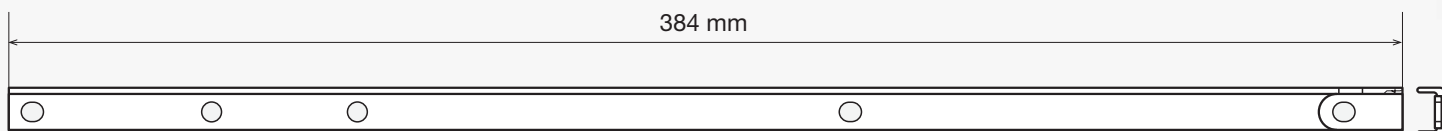

**ART. C045# 0384 FN &**

RINFORZO AD U IN CARBONIO/U CARBON PROFILE



**ART. P511**

SUPPORTO PINZA/GRIPPER SUPPORT

**ART. P512**

SUPPORTO PINZA/GRIPPER SUPPORT

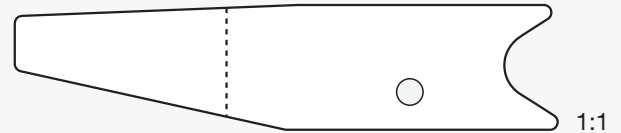

**ART. P513**

SUPPORTO PINZA/GRIPPER SUPPORT

**ART. P514**

SUPPORTO PINZA/GRIPPER SUPPORT

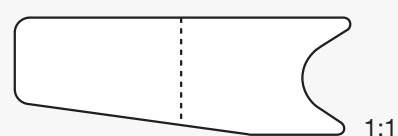
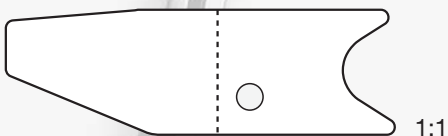

**ART. P515**

SUPPORTO PINZA/GRIPPER SUPPORT

**ART. P517**

SUPPORTO PINZA/GRIPPER SUPPORT





**ART. P519**

INSERTO/INSERT

**ART. P520**

INSERTO/INSERT

Spessori - Thickness:

0,5 mm;  
0,6 mm;  
0,7 mm;  
0,8 mm.

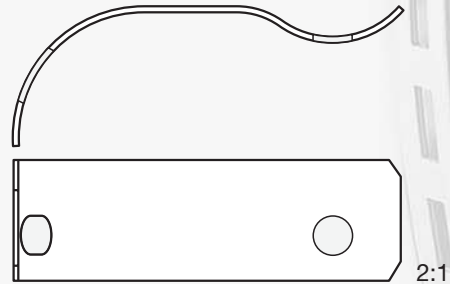
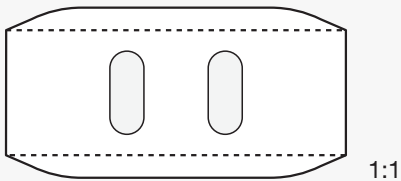

**ART. P518**

APRIPINZA/GRIPPER OPENER

**ART. P523**

MOLLETTINA/SPRING

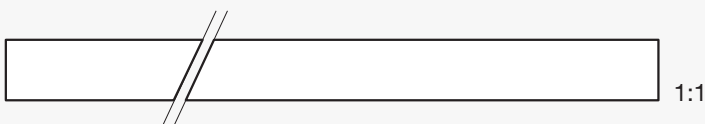

**ART. P524**

MOLLETTINA/SPRING

**ART. P525**

SUPPORTO PINZA/GRIPPER SUPPORT

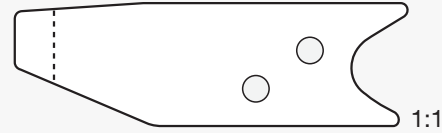
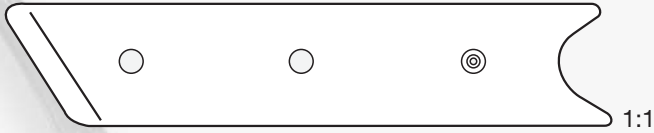
**ART. P526**

SUPPORTO PINZA/GRIPPER SUPPORT

**ART. P527**

SUPPORTO PINZA/GRIPPER SUPPORT

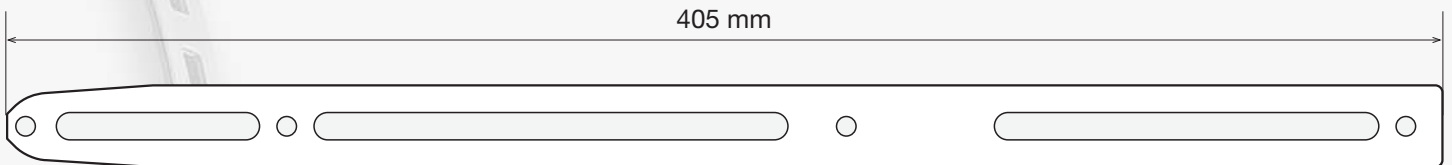
**ART. P521**

APRIPINZA/GRIPPER OPENER

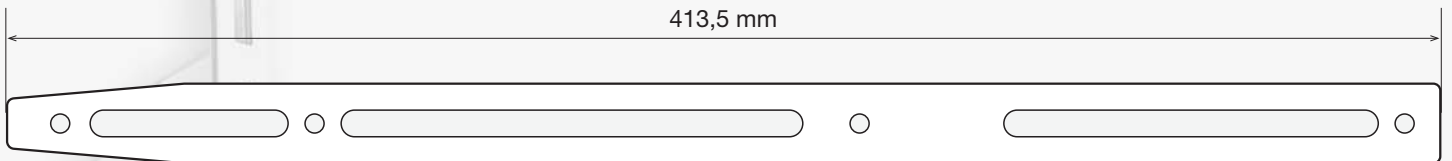
**ART. P522**

APRIPINZA/GRIPPER OPENER

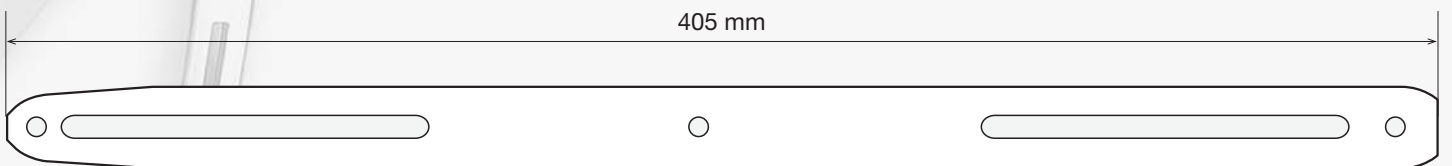
**ART. P537**

APRIPINZA/GRIPPER OPENER



## Nastri originali Lamiflex adatti per telai tipo Jakob Müller

Original Lamiflex flexible tapes suitable for Jakob Müller type looms

**LAMIFLEX**  
ALTA TECNOLOGIA DEI COMPOSITI

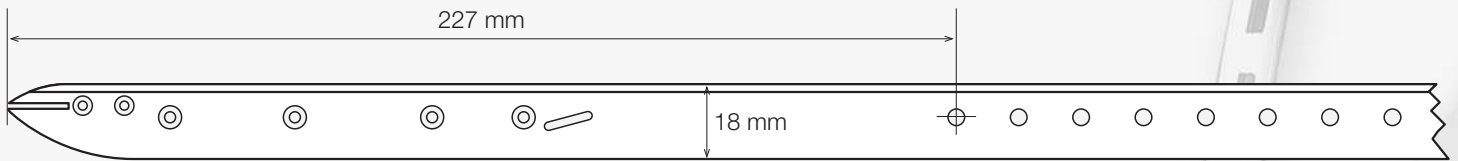

<b>ART. N601</b>	Telaio/Loom MÜLLER	Lungh. nastro Tape length	Codice Lamiflex Lamiflex Code
DX/RIGHT	MUGRIP 3	1077 mm	N601 1077

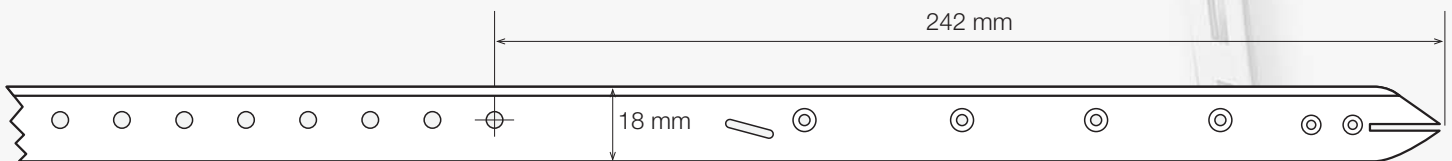

<b>ART. N602</b>	Telaio/Loom MÜLLER	Lungh. nastro Tape length	Codice Lamiflex Lamiflex Code
SX/LEFT	MUGRIP 3	1092 mm	N602 1092

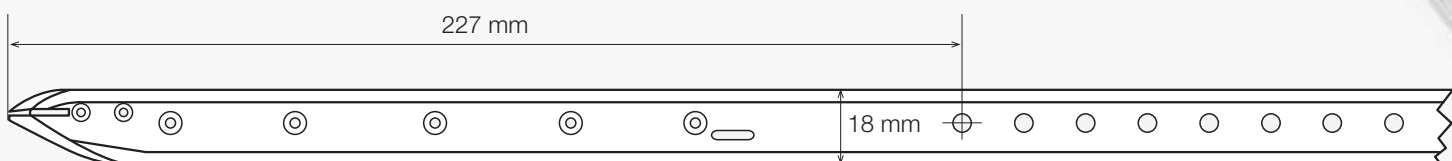

<b>ART. N603</b>	Telaio/Loom MÜLLER	Lungh. nastro Tape length	Codice Lamiflex Lamiflex Code
DX/RIGHT	MUGRIP 3	1077 mm	N603 1077

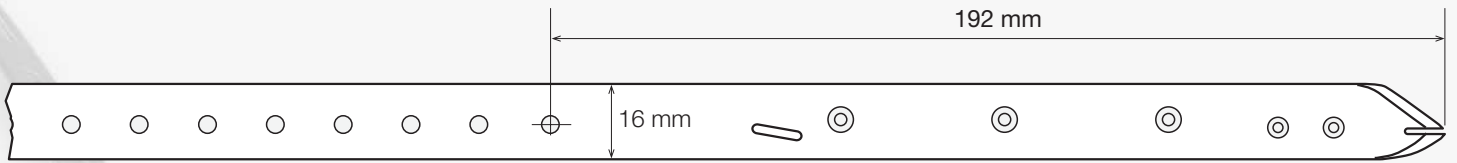

<b>ART. N604</b>	Telaio/Loom MÜLLER	Lungh. nastro Tape length	Codice Lamiflex Lamiflex Code
	DX/RIGHT	MUGRIP 2	952 mm N604 952

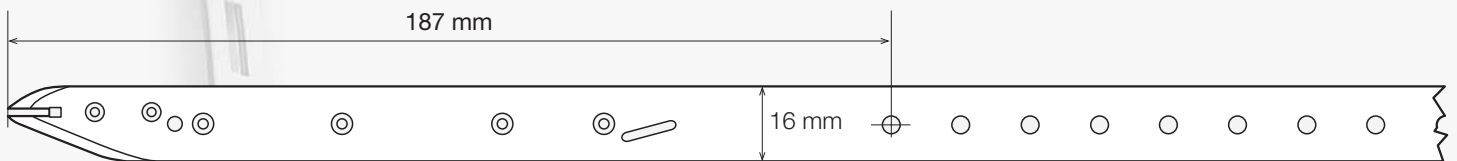

<b>ART. N605</b>	Telaio/Loom MÜLLER	Lungh. nastro Tape length	Codice Lamiflex Lamiflex Code
	SX/LEFT	MUGRIP 2	947 mm N605 947

